

Three-jaw clamps - Series CGCN

Product code: CGCN-064

Datasheet creation date: 10/03/2025 02:31

Check the most updated document online [click here](#)



TECHNICAL DATA

Series	CGCN
Size	064
Atex	= standard

Three-jaw clamps - Series CGCN

Product code: CGCN-064

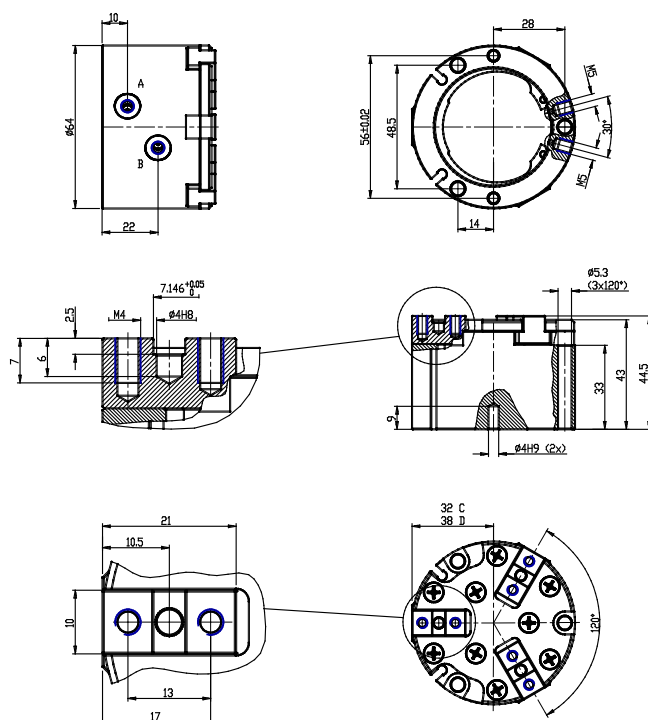

DIMENSIONS

Series	CGCN
Size	064
Atex	= standard
Stroke (mm)	6