

Three-jaw clamps - Series CGCN

Product code: CGCN-125

Datasheet creation date: 10/03/2025 02:31

Check the most updated document online [click here](#)



TECHNICAL DATA

Series	CGCN
Size	125
Atex	= standard

Three-jaw clamps - Series CGCN

Product code: CGCN-125

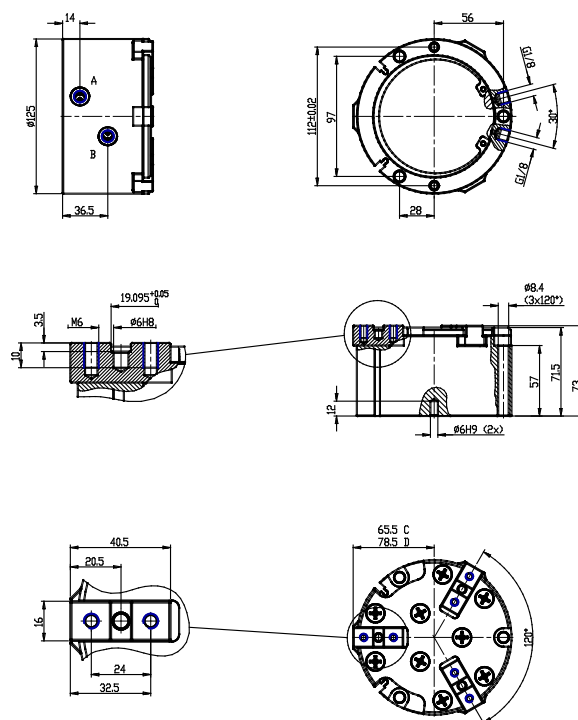

DIMENSIONS

Series	CGCN
Size	125
Atex	= standard
Stroke (mm)	13