

Three-jaw clamps - Series CGZT

Product code: CGZT-100-NC

Datasheet creation date: 10/03/2025 02:37

Check the most updated document online [click here](#)



TECHNICAL DATA

Series	CGZT
Bore	100
Operation	NC= simple acting normally closed
Version	= standard
Atex	= standard

Three-jaw clamps - Series CGZT

Product code: CGZT-100-NC

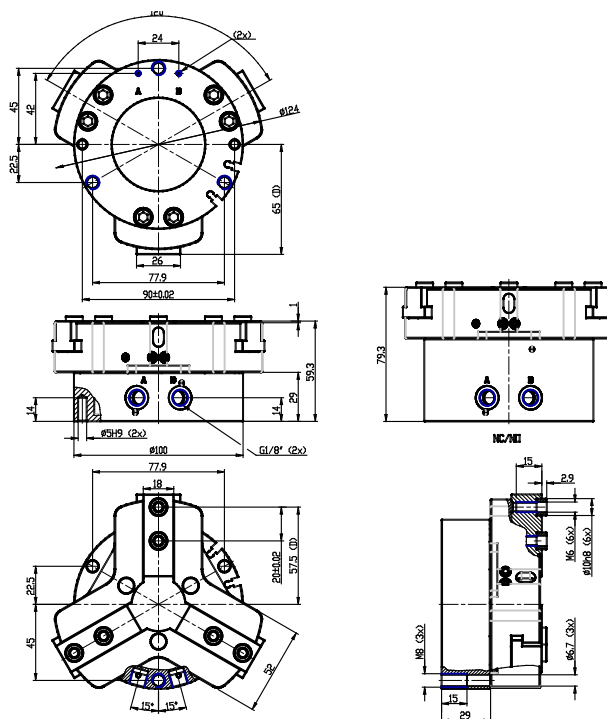

DIMENSIONS

Series	CGZT
Bore	100
Operation	NC= simple acting normally closed
Version	= standard
Atex	= standard