

Micro pressure regulators - Series CLR

Product code: CLR 1/8-01-8

Datasheet creation date: 10/03/2025 00:43

Check the most updated document online [click here](#)



TECHNICAL DATA

Mod.	CLR 1/8-01-8
------	--------------

Micro pressure regulators - Series CLR

Product code: CLR 1/8-01-8

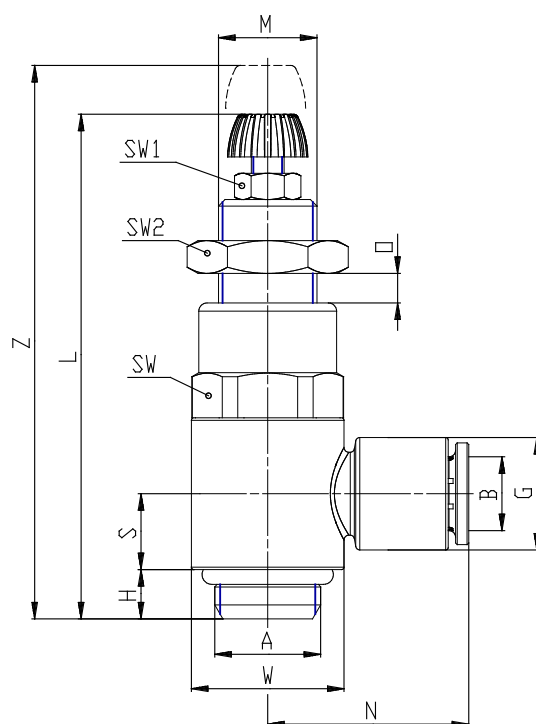

DIMENSIONS

Mod.	CLR 1/8-01-8
------	--------------