

Manifold bars with separate exhausts (low version) - Series 3

Product code: CNV-318-2

Datasheet creation date: 07/03/2025 16:13

Check the most updated document online [click here](#)



TECHNICAL DATA

Mod.	CNV-318-2
N° of valves (mm)	2

Manifold bars with separate exhausts (low version) - Series 3

Product code: CNV-318-2

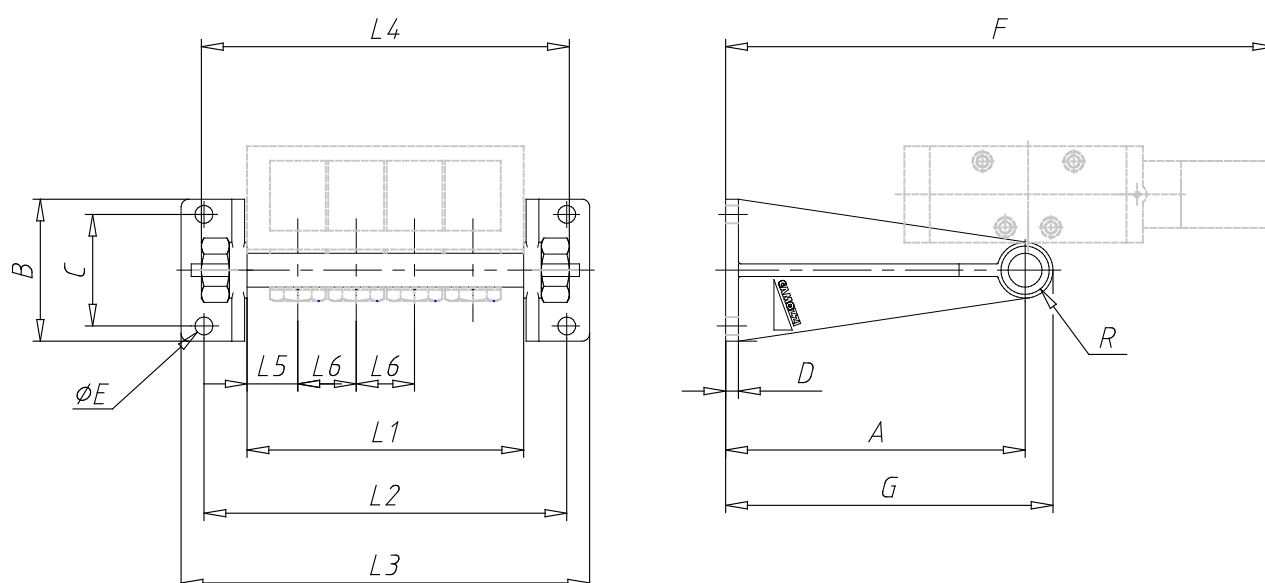

DIMENSIONS

A (mm)	73
B (mm)	56
C (mm)	44
D (mm)	5
E (Ø) (mm)	7
F (mm)	178
G (mm)	83
R	G1/4
L1 (mm)	63
L2 (mm)	97
L3 (mm)	115
L4 (mm)	99
L5 (mm)	20
L6 (mm)	23
Suitable for	Series 3 - G 1/8