

Terminal plates for supplementary intermediate - Series 3

Product code: CNVL-4P

Datasheet creation date: 20/05/2026 06:52

Check the most updated document online [click here](#)



■ TECHNICAL DATA

Mod.	CNVL-4P
------	---------

Terminal plates for supplementary intermediate - Series 3

Product code: CNVL-4P

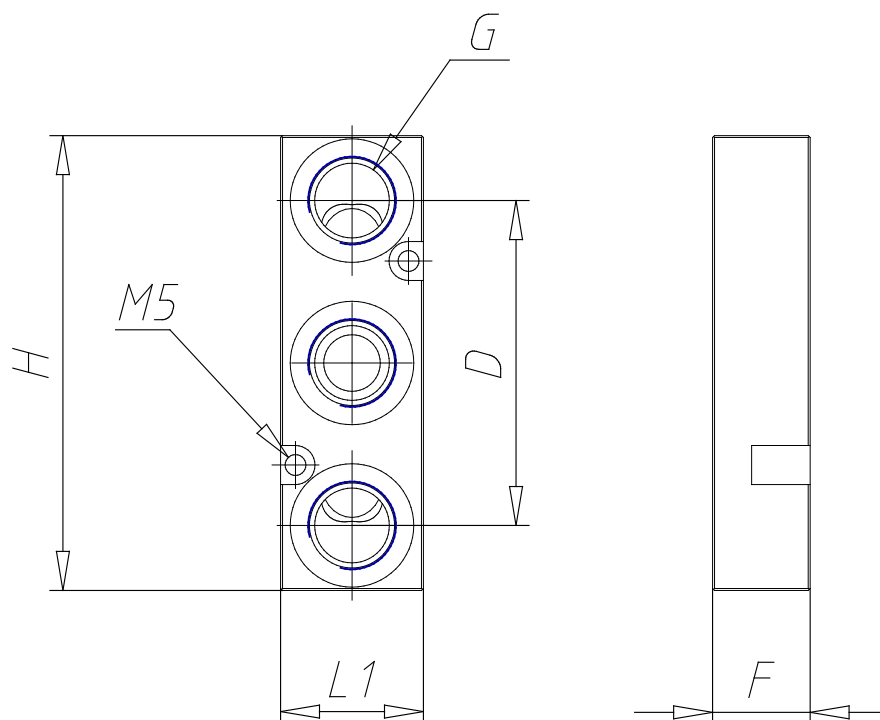

DIMENSIONS

G	G1/4
H (mm)	73
M (mm)	3.2
F (mm)	20
L1 (mm)	25
D (mm)	50
F1 (mm)	20