

## Elastomer joint with terminals - Series CO

Product code: COE-05-0800-0635-A

Datasheet creation date: 07/03/2025 15:45

Check the most updated document online [click here](#)



### TECHNICAL DATA

<b>Series</b>	COE
<b>Size</b>	05
<b>Diameter 1 (mm)</b>	0800= 8.00mm
<b>Diameter 2 (mm)</b>	0635= 6.35mm
<b>Hardness</b>	A= 98 Sh A

## Elastomer joint with terminals - Series CO

Product code: COE-05-0800-0635-A

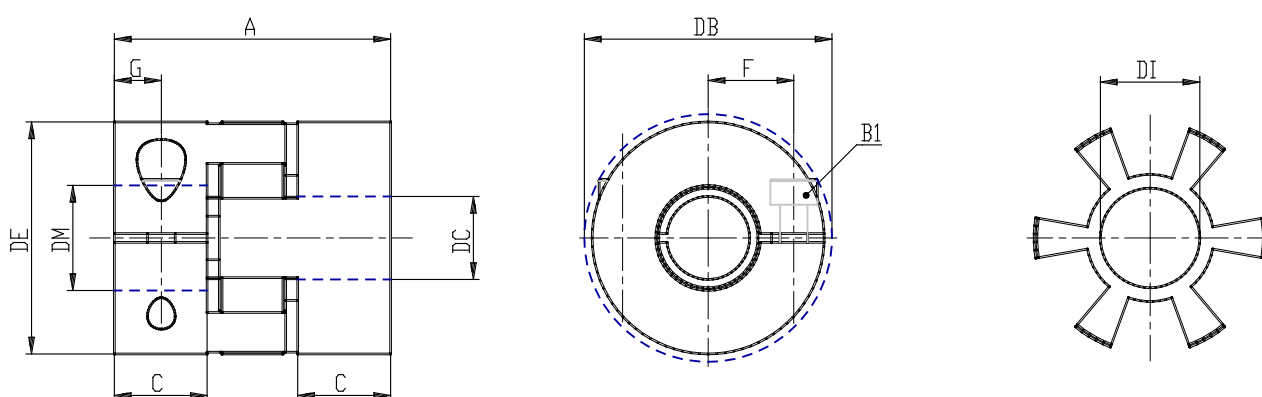

### DIMENSIONS

<b>DE (mm)</b>	25
<b>DB (mm)</b>	25.0
<b>DI (mm)</b>	10.2
<b>A (mm)</b>	26
<b>C (mm)</b>	8.0
<b>F (mm)</b>	8.0
<b>G (mm)</b>	4.0
<b>B1 (mm)</b>	M3 (CH2.5)
<b>Torque (nm)</b>	2
<b>P (g)</b>	20