

Elastomer joint with terminals - Series CO

Product code: COE-10-1500-0800-A

Datasheet creation date: 07/03/2025 15:45

Check the most updated document online [click here](#)



TECHNICAL DATA

Series	COE
Size	10
Diameter 1 (mm)	1500= 15.00mm
Diameter 2 (mm)	0800= 8.00mm
Hardness	A= 98 Sh A

Elastomer joint with terminals - Series CO

Product code: COE-10-1500-0800-A

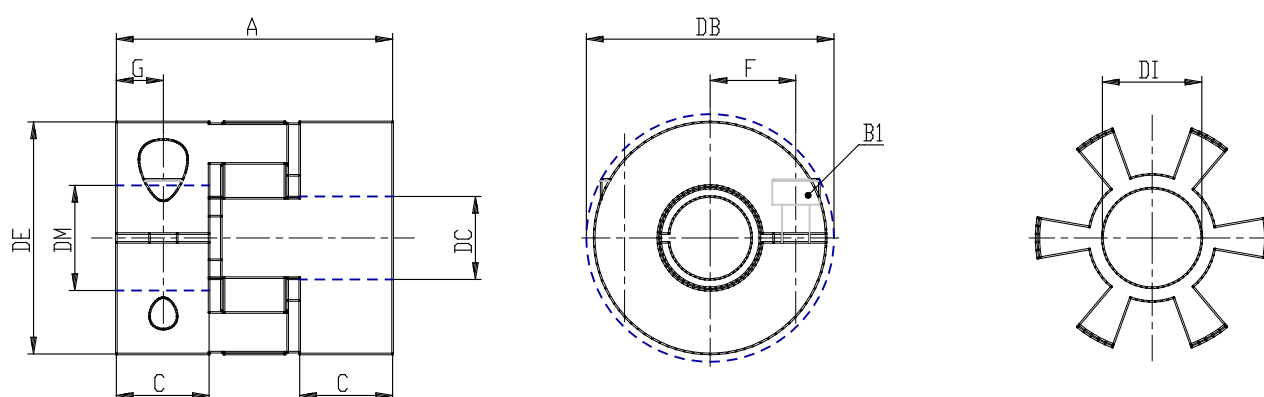

DIMENSIONS

DE (mm)	32
DB (mm)	32.0
DI (mm)	14.2
A (mm)	32
C (mm)	10.3
F (mm)	10.5
G (mm)	5.0
B1 (mm)	M4 (CH3)
Torque (nm)	4
P (g)	50