

Elastomer joint with terminals - Series CO

Product code: COE-20-1400-2400-A

Datasheet creation date: 07/03/2025 15:45

Check the most updated document online [click here](#)



TECHNICAL DATA

Series	COE
Size	20
Diameter 1 (mm)	1400= 14.00mm
Diameter 2 (mm)	2400= 24.00mm
Hardness	A= 98 Sh A

Elastomer joint with terminals - Series CO

Product code: COE-20-1400-2400-A

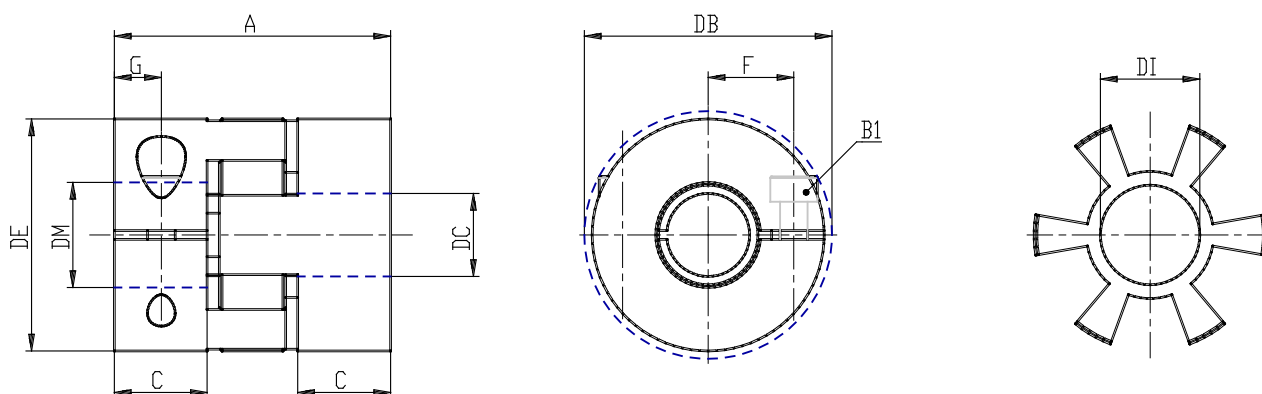

DIMENSIONS

DE (mm)	42
DB (mm)	44.5
DI (mm)	19.2
A (mm)	50
C (mm)	17.0
F (mm)	15.5
G (mm)	8.5
B1 (mm)	M5 (CH4)
Torque (nm)	8
P (g)	120