

## Elastomer joint with terminals - Series CO

Product code: COE-20-1600-2000-A

Datasheet creation date: 07/03/2025 15:45

Check the most updated document online [click here](#)



### TECHNICAL DATA

<b>Series</b>	COE
<b>Size</b>	20
<b>Diameter 1 (mm)</b>	1600= 16.00mm
<b>Diameter 2 (mm)</b>	2000= 20.00mm
<b>Hardness</b>	A= 98 Sh A

## Elastomer joint with terminals - Series CO

Product code: COE-20-1600-2000-A

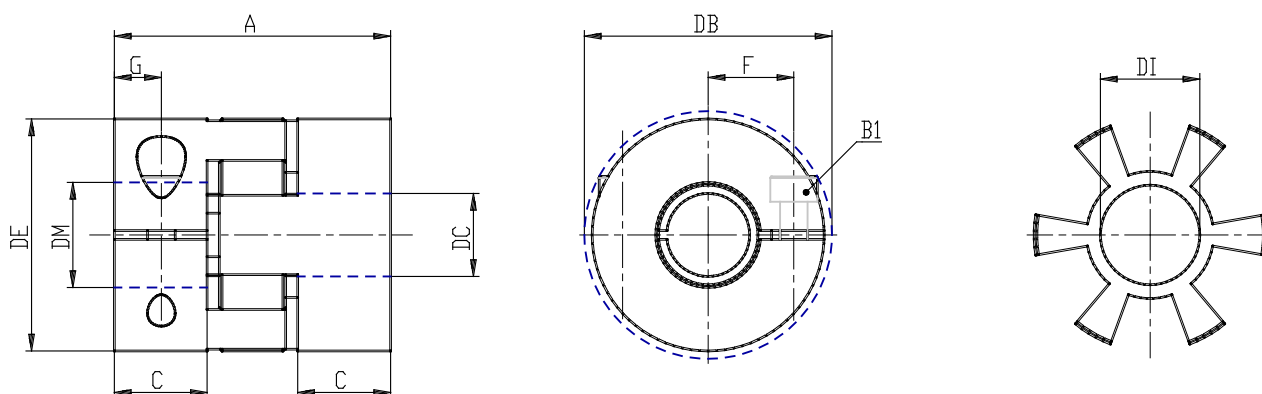

### DIMENSIONS

DE (mm)	42
DB (mm)	44.5
DI (mm)	19.2
A (mm)	50
C (mm)	17.0
F (mm)	15.5
G (mm)	8.5
B1 (mm)	M5 (CH4)
Torque (nm)	8
P (g)	120