

Elastomer joint with terminals - Series CO

Product code: COE-60-2500-3200-A

Datasheet creation date: 07/03/2025 15:46

Check the most updated document online [click here](#)



TECHNICAL DATA

Series	COE
Size	60
Diameter 1 (mm)	2500= 25.00mm
Diameter 2 (mm)	3200= 32.00mm
Hardness	A= 98 Sh A

Elastomer joint with terminals - Series CO

Product code: COE-60-2500-3200-A

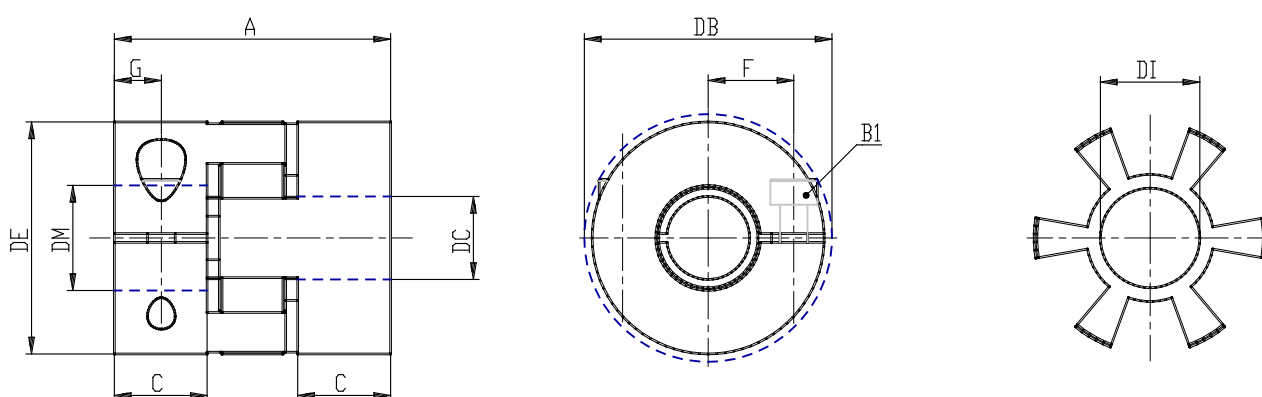

DIMENSIONS

DE (mm)	56
DB (mm)	57.0
DI (mm)	26.2
A (mm)	58
C (mm)	20.0
F (mm)	21.0
G (mm)	10.0
B1 (mm)	M6 (CH5)
Torque (nm)	15
P (g)	300