

Elastomer joint with expansion shaft - Series CO

Product code: COS-10-2000-0800-A

Datasheet creation date: 07/03/2025 15:46

Check the most updated document online [click here](#)



TECHNICAL DATA

Series	COS
Size	10
Rod diameter (mm)	2000= 20.00mm
Hole diameter (mm)	0800= 8.00mm
Hardness	A= 98 Sh A

Elastomer joint with expansion shaft - Series CO

Product code: COS-10-2000-0800-A

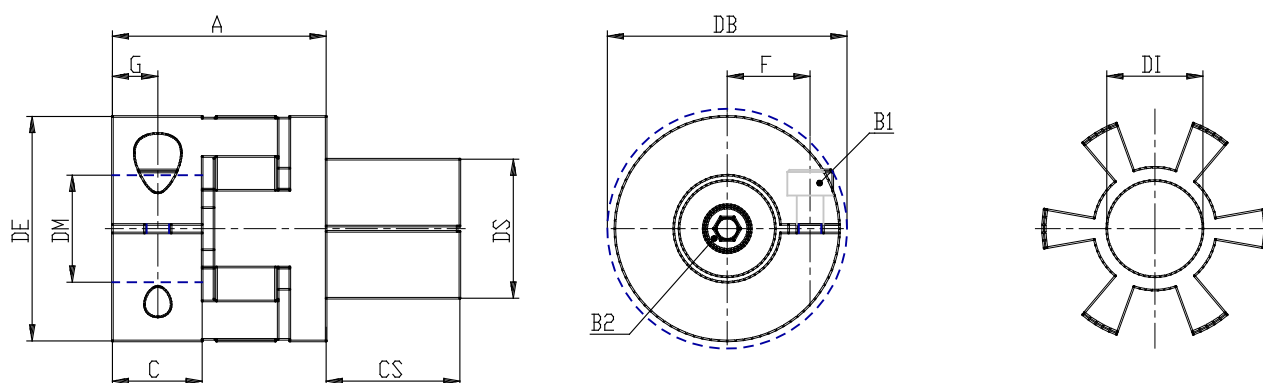

DIMENSIONS

DS (mm)	20
DE (mm)	32
DB (mm)	32.0
DI (mm)	14.2
A (mm)	28
C (mm)	10.3
F (mm)	10.5
G (mm)	5.0
B1	M4 (CH3)
P (g)	50
DM (mm)	8.000