

## Elastomer joint with expansion shaft - Series CO

Product code: COS-10-2000-1400-A

Datasheet creation date: 07/03/2025 15:46

Check the most updated document online [click here](#)



### TECHNICAL DATA

<b>Series</b>	COS
<b>Size</b>	10
<b>Rod diameter (mm)</b>	2000= 20.00mm
<b>Hole diameter (mm)</b>	1400= 14.00mm
<b>Hardness</b>	A= 98 Sh A

## Elastomer joint with expansion shaft - Series CO

Product code: COS-10-2000-1400-A

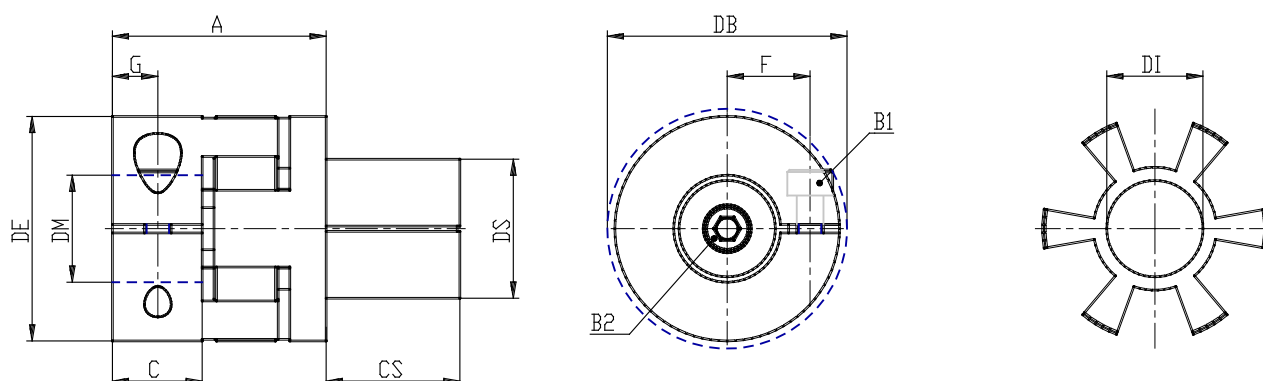

### DIMENSIONS

DS (mm)	20
DE (mm)	32
DB (mm)	32.0
DI (mm)	14.2
A (mm)	28
C (mm)	10.3
F (mm)	10.5
G (mm)	5.0
B1	M4 (CH3)
P (g)	50
DM (mm)	14.000