

Elastomer joint with expansion shaft - Series CO

Product code: COS-20-2600-1200-A

Datasheet creation date: 07/03/2025 15:46

Check the most updated document online [click here](#)



TECHNICAL DATA

Series	COS
Size	20
Rod diameter (mm)	2600= 26.00mm
Hole diameter (mm)	1200= 12.00mm
Hardness	A= 98 Sh A

Elastomer joint with expansion shaft - Series CO

Product code: COS-20-2600-1200-A

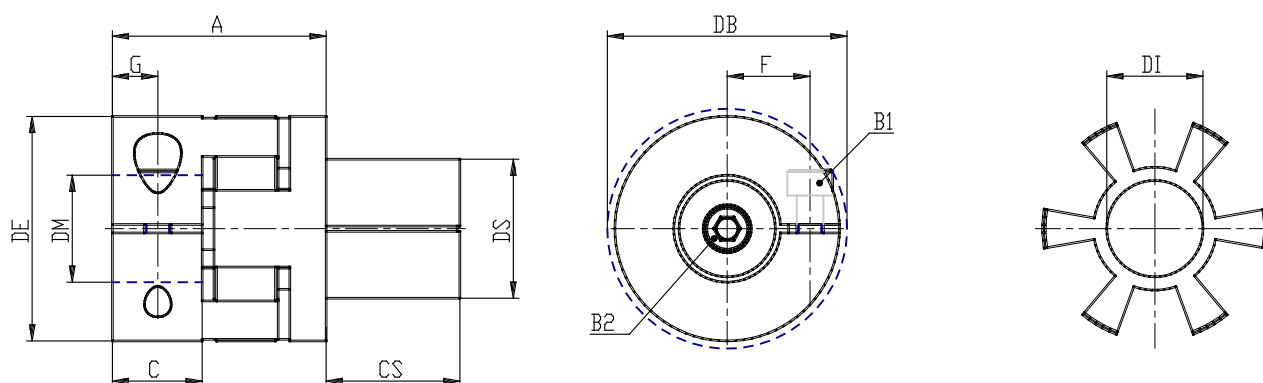

DIMENSIONS

DS (mm)	26
DE (mm)	42
DB (mm)	44.5
DI (mm)	19.2
A (mm)	40
C (mm)	17.0
F (mm)	15.5
G (mm)	8.5
B1	M5 (CH4)
P (g)	120
DM (mm)	12.000