

## Elastomer joint with expansion shaft - Series CO

Product code: COS-20-2600-2000-A

Datasheet creation date: 07/03/2025 15:46

Check the most updated document online [click here](#)



### TECHNICAL DATA

<b>Series</b>	COS
<b>Size</b>	20
<b>Rod diameter (mm)</b>	2600= 26.00mm
<b>Hole diameter (mm)</b>	2000= 20.00mm
<b>Hardness</b>	A= 98 Sh A

## Elastomer joint with expansion shaft - Series CO

Product code: COS-20-2600-2000-A

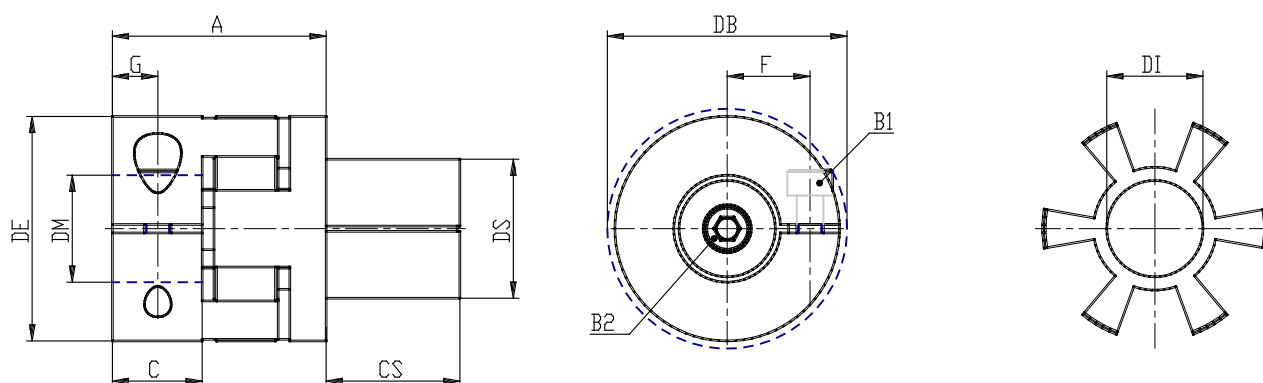

### DIMENSIONS

DS (mm)	26
DE (mm)	42
DB (mm)	44.5
DI (mm)	19.2
A (mm)	40
C (mm)	17.0
F (mm)	15.5
G (mm)	8.5
B1	M5 (CH4)
P (g)	120
DM (mm)	20.000