

Elastomer joint with expansion shaft - Series CO

Product code: COS-60-3800-2500-A

Datasheet creation date: 07/03/2025 15:46

Check the most updated document online [click here](#)



TECHNICAL DATA

Series	COS
Size	60
Rod diameter (mm)	3800= 38.00mm
Hole diameter (mm)	2500= 25.00mm
Hardness	A= 98 Sh A

Elastomer joint with expansion shaft - Series CO

Product code: COS-60-3800-2500-A

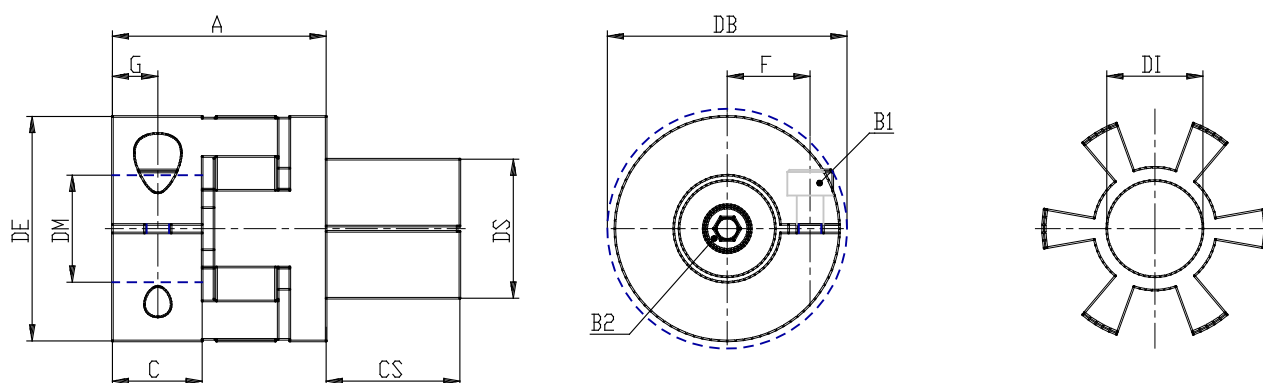

DIMENSIONS

DS (mm)	38
DE (mm)	56
DB (mm)	57.0
DI (mm)	26.2
A (mm)	46
C (mm)	20.0
F (mm)	21.0
G (mm)	10.0
B1	M6 (CH5)
P (g)	300
DM (mm)	25.000