

## Subbase - Series CP

Product code: CP-S6

Datasheet creation date: 10/03/2025 10:54

Check the most updated document online [click here](#)



### TECHNICAL DATA

Mod.	CP-S6
------	-------

## Subbase - Series CP

Product code: CP-S6

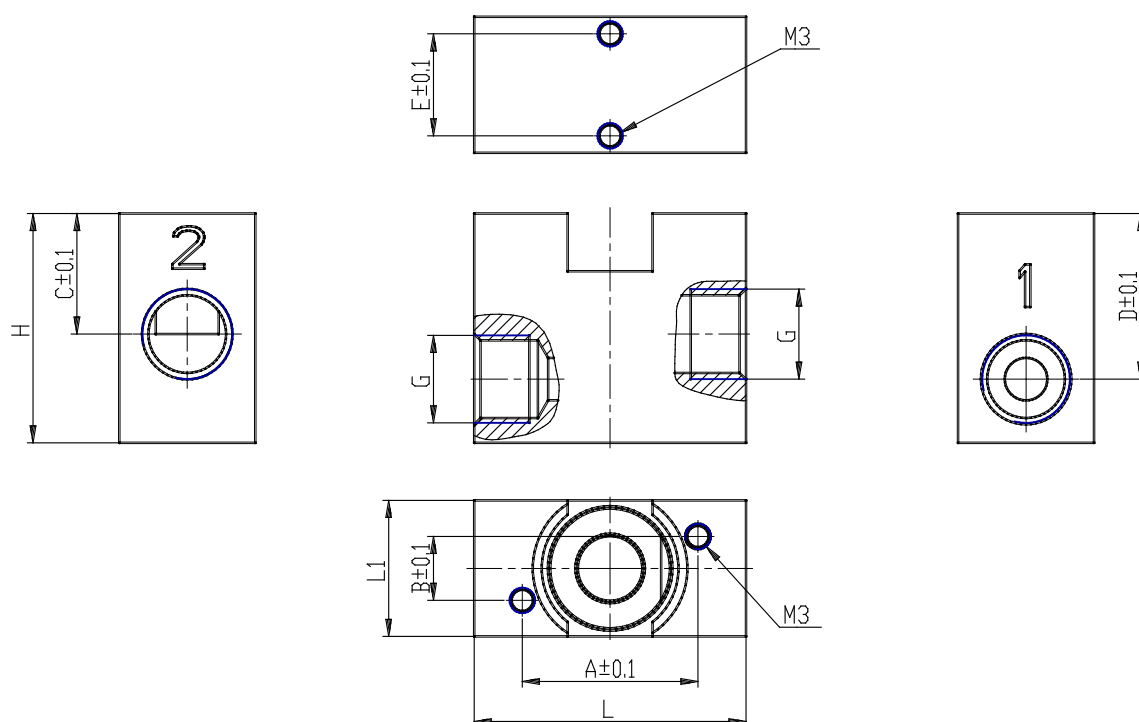

### DIMENSIONS

<b>A (mm)</b>	20.70
<b>B (mm)</b>	7.50
<b>C (mm)</b>	14.2
<b>D (mm)</b>	19.5
<b>E (mm)</b>	12
<b>G (mm)</b>	1/8 G
<b>H (mm)</b>	27.0
<b>L (mm)</b>	32
<b>L1 (mm)</b>	16