

## Angular connector for power supply - Mod. CS-LR

Product code: CS-LR05HB-C500

Datasheet creation date: 10/03/2025 10:54

Check the most updated document online [click here](#)



### TECHNICAL DATA

Mod.	CS-LR05HB-C500
------	----------------

## Angular connector for power supply - Mod. CS-LR

Product code: CS-LR05HB-C500

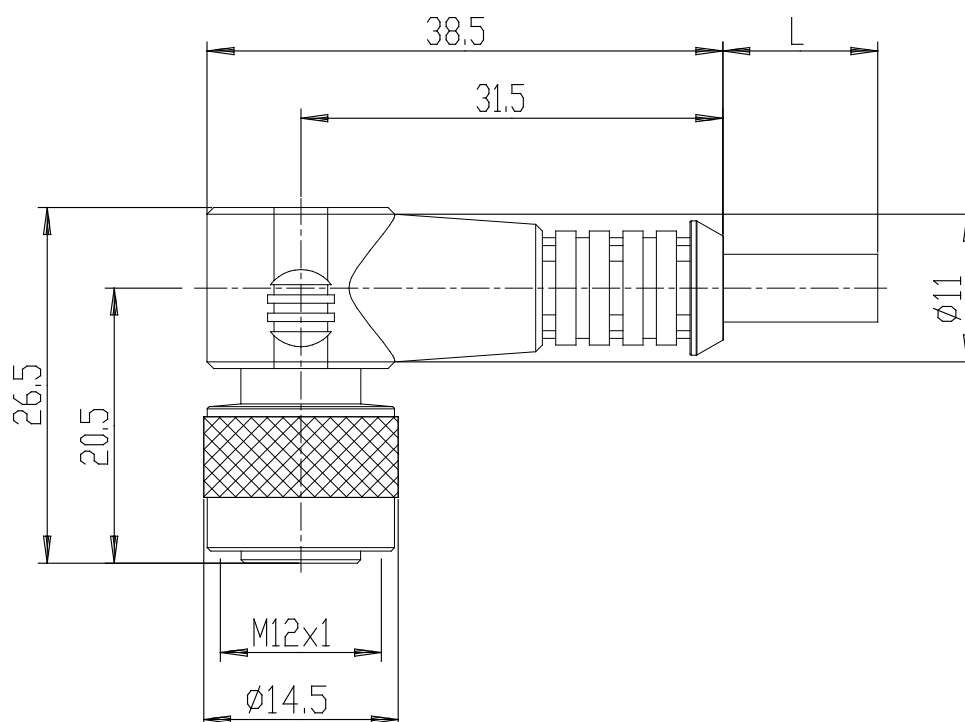

### DIMENSIONS

Mod.	CS-LR05HB-C500
------	----------------