

## Magnetic proximity switches, ATEX "II 3 GD" certified, T-slot, straight - Series CSG

Product code: CSG-223-2-UL

Datasheet creation date: 10/03/2025 10:47

Check the most updated document online [click here](#)



### TECHNICAL DATA

<b>Mod.</b>	CSG-223-2-UL
<b>Operation</b>	Reed
<b>Connection</b>	2 wires
<b>Voltage</b>	5 ÷ 30 V AC/DC
<b>Exit</b>	-
<b>Max. current</b>	60 mA
<b>Max Load</b>	1.8 W
<b>Protection</b>	IP67

## Magnetic proximity switches, ATEX "II 3 GD" certified, T-slot, straight - Series CSG

Product code: CSG-223-2-UL

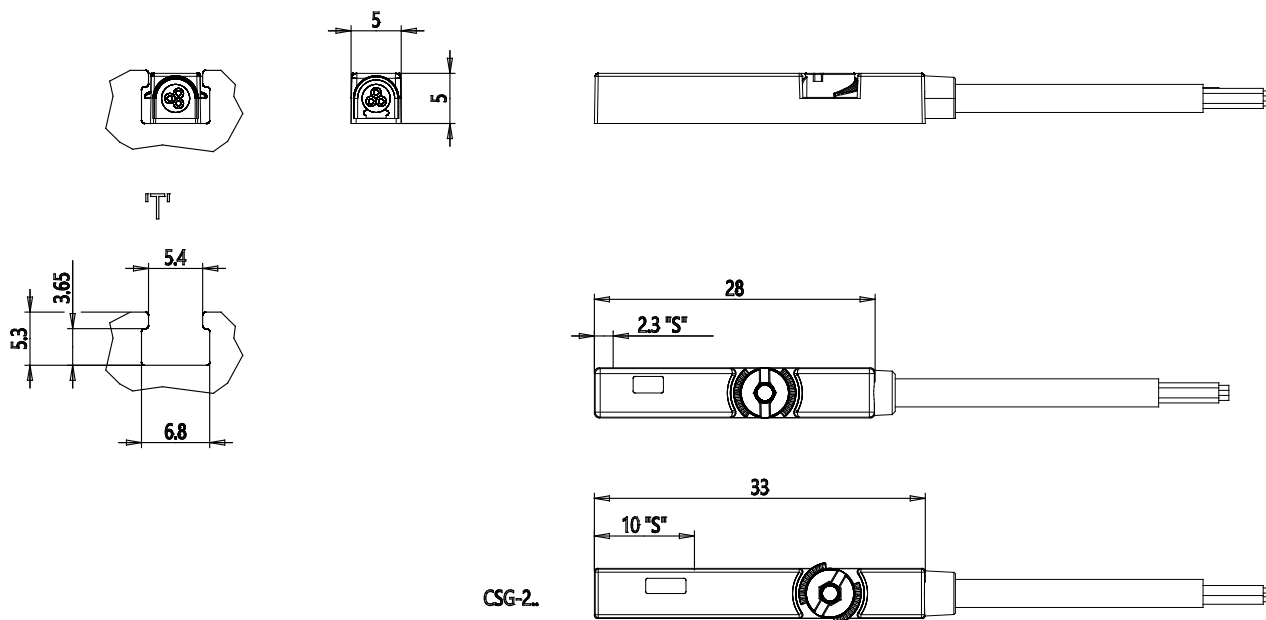

### DIMENSIONS

<b>Mod.</b>	CSG-223-2-UL
<b>Operation</b>	Reed
<b>Connection</b>	2 wires
<b>Voltage</b>	5 ÷ 30 V AC/DC
<b>Exit</b>	-
<b>Max. current</b>	60 mA
<b>Max Load</b>	1.8 W
<b>Protection</b>	IP67