

Magnetic proximity switches, ATEX "II 3 GD" certified, T-slot, straight - Series CSG

Product code: CSG-233-2-UL

Datasheet creation date: 10/03/2025 10:47

Check the most updated document online [click here](#)



TECHNICAL DATA

Mod.	CSG-233-2-UL
Operation	Reed
Connection	3 wires
Voltage	10 ÷ 30 V AC/DC
Exit	-
Max. current	100 mA
Max Load	3 W
Protection	IP67

Magnetic proximity switches, ATEX "II 3 GD" certified, T-slot, straight - Series CSG

Product code: CSG-233-2-UL

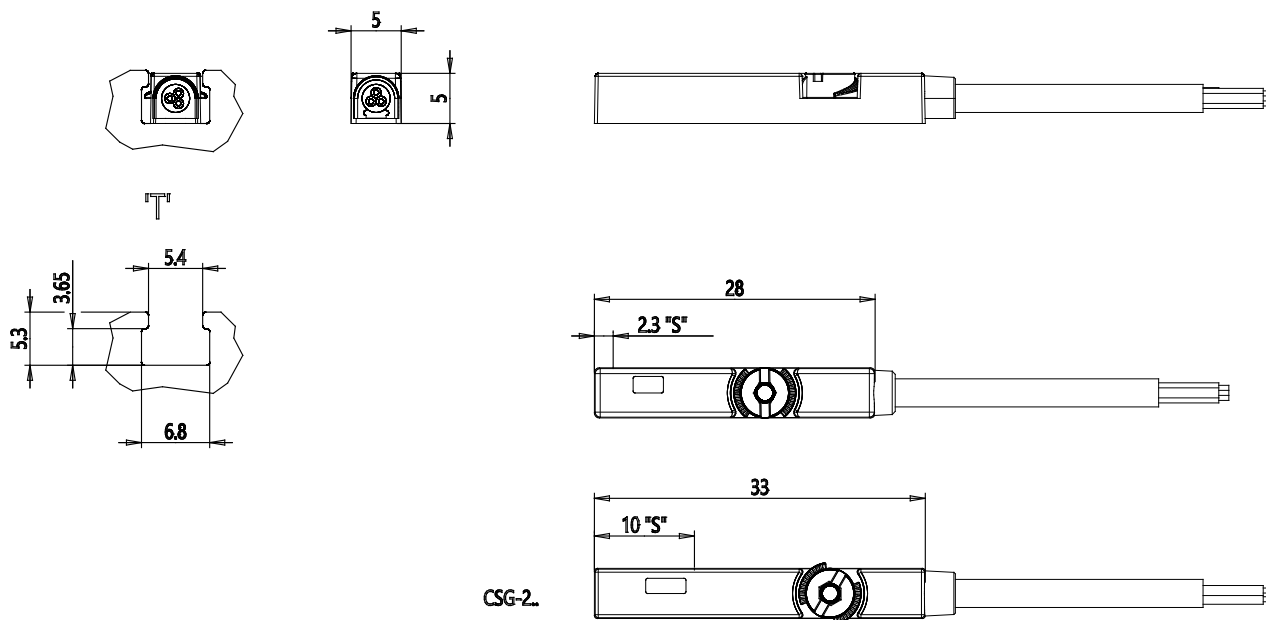

DIMENSIONS

Mod.	CSG-233-2-UL
Operation	Reed
Connection	3 wires
Voltage	10 ÷ 30 V AC/DC
Exit	-
Max. current	100 mA
Max Load	3 W
Protection	IP67