

Magnetic proximity switches, ATEX "II 3 GD" certified, T-slot, straight - Series CSG

Product code: CSG-324-5

Datasheet creation date: 10/03/2025 10:47

Check the most updated document online [click here](#)



TECHNICAL DATA

Mod.	CSG-324-5
Operation	Magneto-resistive
Connection	2 wires

Magnetic proximity switches, ATEX "II 3 GD" certified, T-slot, straight - Series CSG

Product code: CSG-324-5

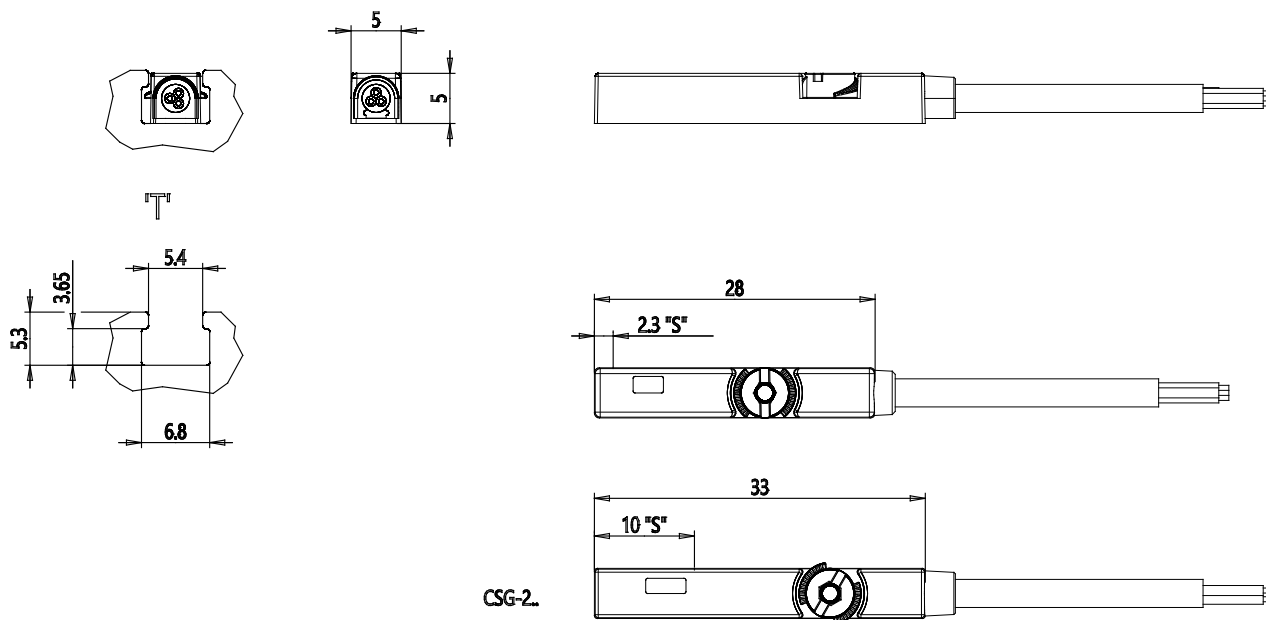

DIMENSIONS

Voltage	10 ÷ 28 V DC
Exit	-
Max. current	50 mA
Max Load	1.5 W
Protection	IP67
Cable length (m)	5 mt