

Magnetic proximity switches, ATEX "II 3 GD" certified, T-slot, straight - Series CSG

Product code: CSG-334-5-EX

Datasheet creation date: 10/03/2025 10:48

Check the most updated document online [click here](#)



TECHNICAL DATA

Mod.	CSG-334-5-EX
Operation	Magneto-resistive NO
Connection	3 wires
Voltage	10 ÷ 28 V DC
Exit	PNP
Max. current	200 mA
Max Load	5.5 W
Protection	IP67

Magnetic proximity switches, ATEX "II 3 GD" certified, T-slot, straight - Series CSG

Product code: CSG-334-5-EX

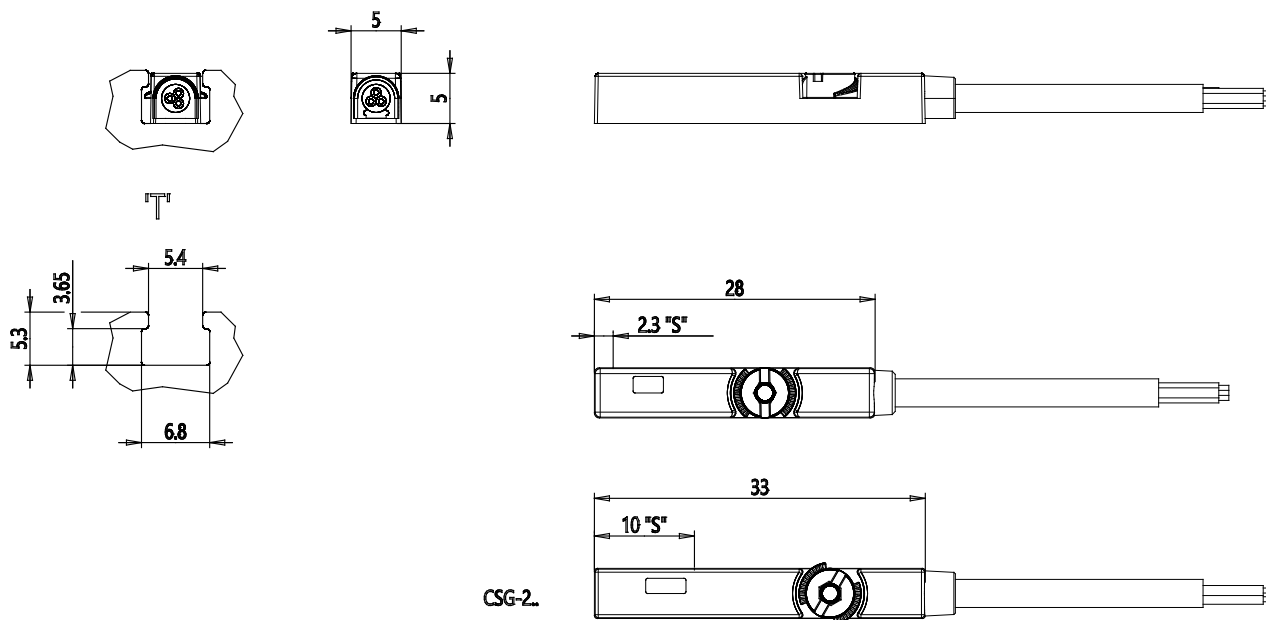

DIMENSIONS

Mod.	CSG-334-5-EX
Operation	Magneto-resistive NO
Connection	3 wires
Voltage	10 ÷ 28 V DC
Exit	PNP
Max. current	200 mA
Max Load	5.5 W
Protection	IP67