

## Magnetic proximity switches, ATEX "II 3 GD" certified, T-slot, straight - Series CSG

Product code: CSG-634-5-EX

Datasheet creation date: 10/03/2025 10:48

Check the most updated document online [click here](#)



### TECHNICAL DATA

<b>Mod.</b>	CSG-634-5-EX
<b>Operation</b>	Magneto-resistive NC
<b>Connection</b>	3 wires
<b>Voltage</b>	10 ÷ 28 V DC
<b>Exit</b>	PNP
<b>Max. current</b>	200 mA
<b>Max Load</b>	5.5 W
<b>Protection</b>	IP67

## Magnetic proximity switches, ATEX "II 3 GD" certified, T-slot, straight - Series CSG

Product code: CSG-634-5-EX

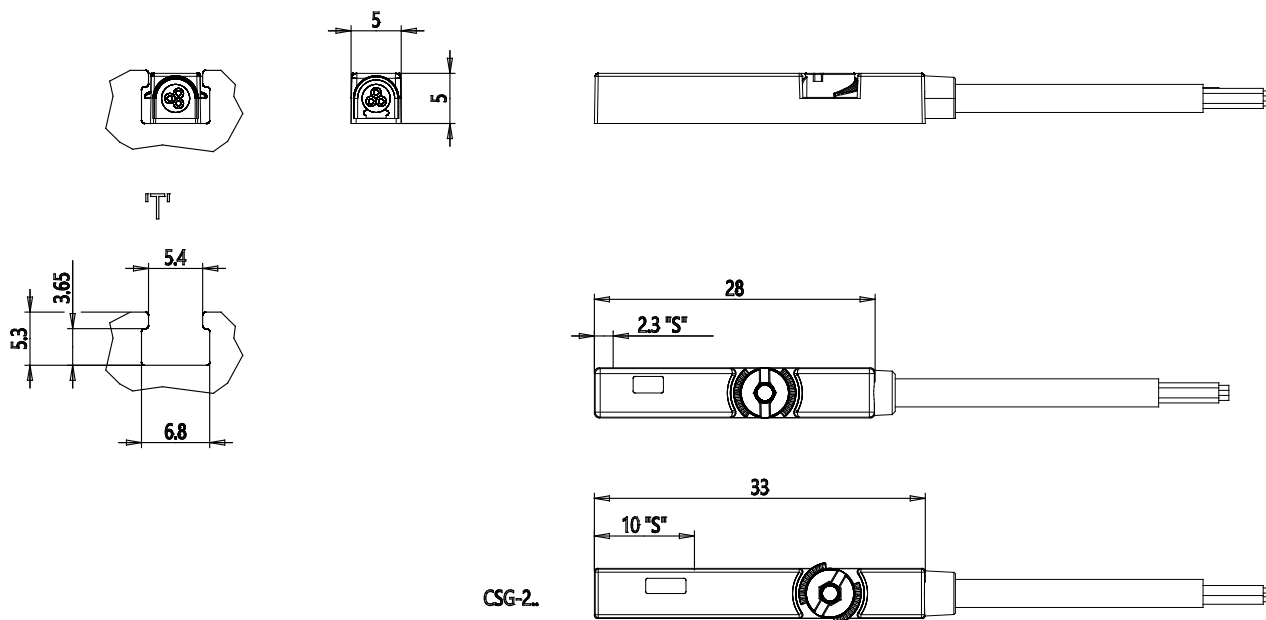

### DIMENSIONS

<b>Mod.</b>	CSG-634-5-EX
<b>Operation</b>	Magneto-resistive NC
<b>Connection</b>	3 wires
<b>Voltage</b>	10 ÷ 28 V DC
<b>Exit</b>	PNP
<b>Max. current</b>	200 mA
<b>Max Load</b>	5.5 W
<b>Protection</b>	IP67