

Magnetic proximity switch - Series CST,CSV e CSH

Product code: CSH-233-5

Datasheet creation date: 10/03/2025 10:49

Check the most updated document online [click here](#)



TECHNICAL DATA

Mod.	CSH-233-5
Description	Reed sensor 3 wires 10-30V AC-DC with cable 5 mt

Magnetic proximity switch - Series CST,CSV e CSH

Product code: CSH-233-5

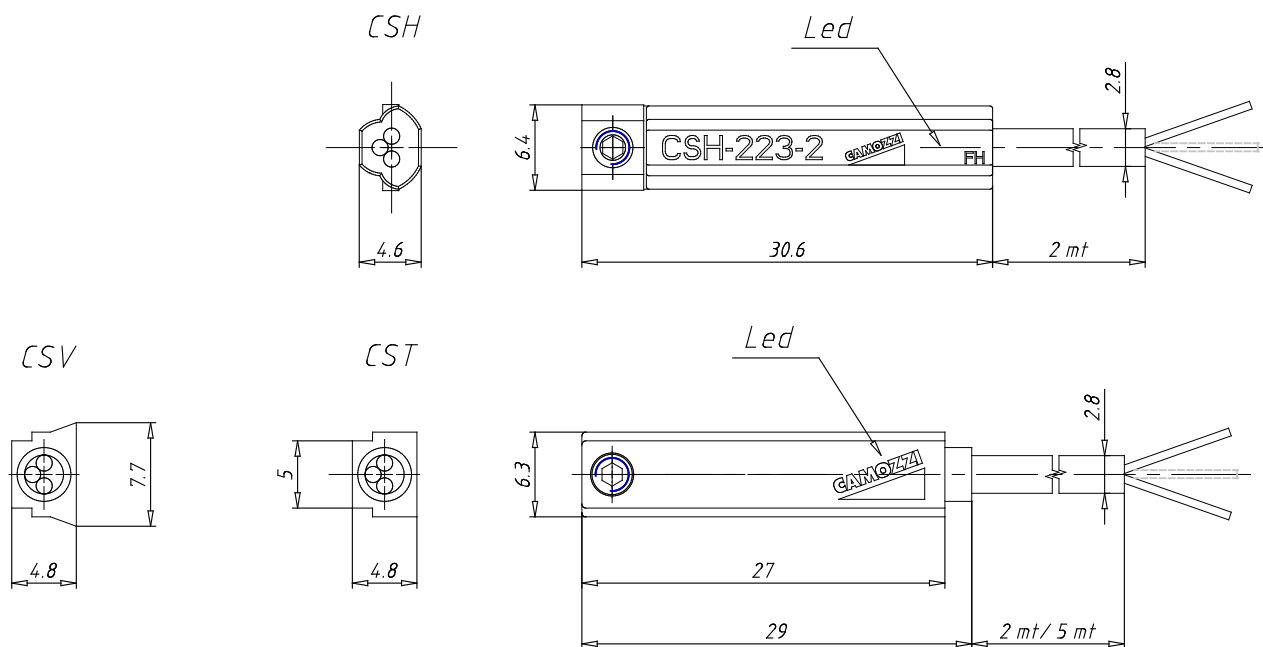

DIMENSIONS

Mod.	CSH-233-5
Description	Reed sensor 3 wires 10-30V AC-DC with cable 5 mt