

Rear and front flange - Mod. D- E

Product code: D-E-31-32

Datasheet creation date: 07/03/2025 15:56

Check the most updated document online [click here](#)

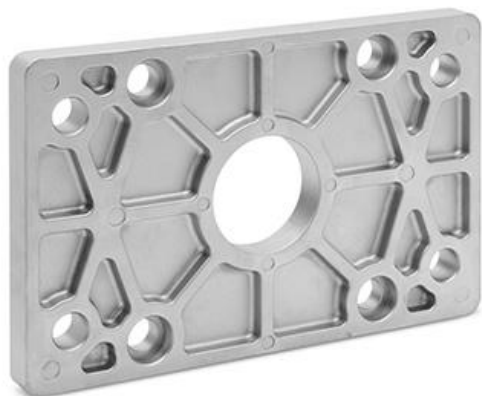

TECHNICAL DATA

Mod.	D-E-31-32
------	-----------

Rear and front flange - Mod. D- E

Product code: D-E-31-32

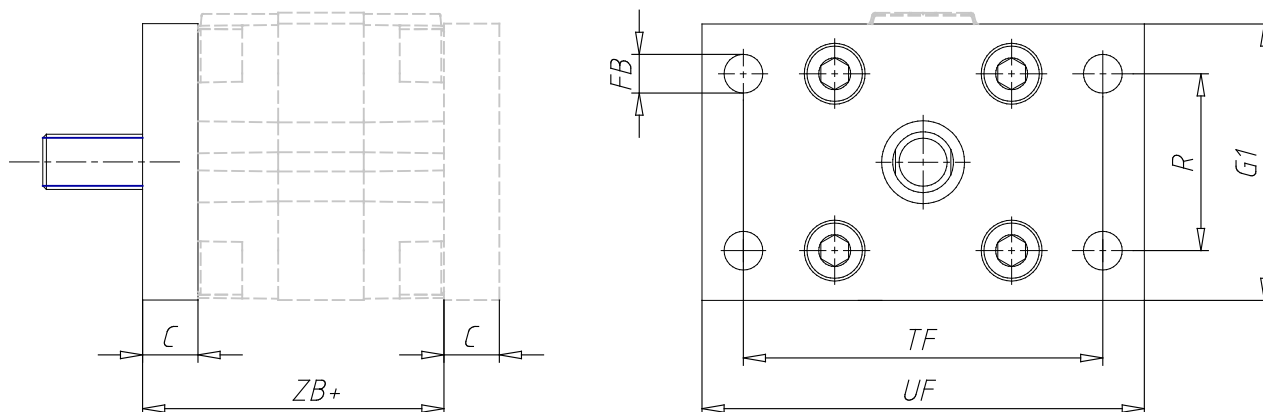

DIMENSIONS

C (mm)	10
ZB (mm)	54.5
TF (mm)	65
R (mm)	32
UF (mm)	80
G1 (mm)	50
Ø FB (mm)	7.0