

Front and rear flange - Mod. D-E

Product code: D-E-41-125

Datasheet creation date: 07/03/2025 16:02

Check the most updated document online [click here](#)

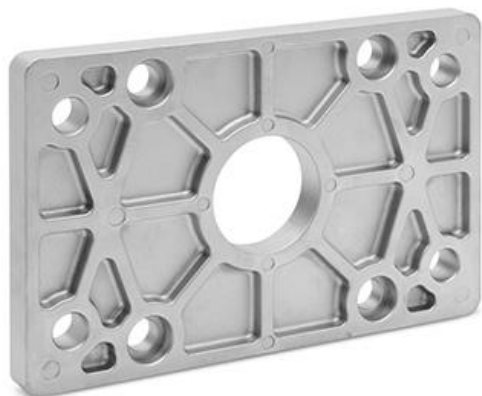

TECHNICAL DATA

Mod.	D-E-41-125
------	------------

Front and rear flange - Mod. D-E

Product code: D-E-41-125

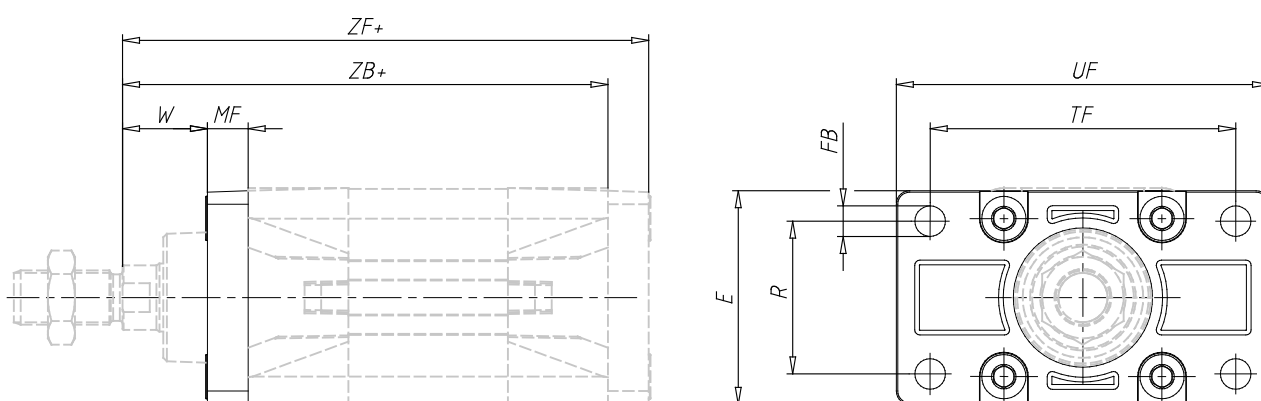

DIMENSIONS

W (mm)	45
MF (mm)	20
ZB (mm)	225
TF (mm)	180
R (mm)	90
UF (mm)	220
E (mm)	140
FB H13 (mm)	16
ZF (mm)	245
Torque force	20 Nm