

Module for additional supply and exhaust - Series D (VB)

Product code: D2AVB-X

Datasheet creation date: 07/03/2025 16:19

Check the most updated document online [click here](#)

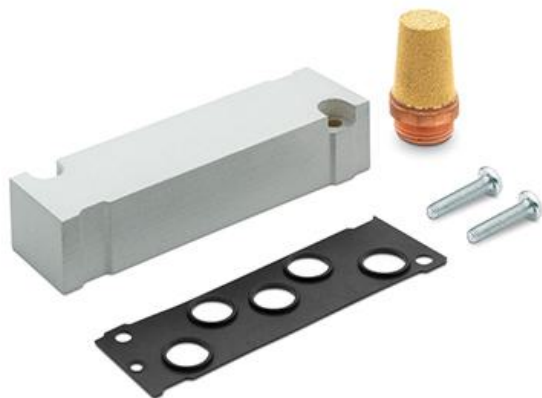

TECHNICAL DATA

Mod.	D2AVB-X
Size (mm)	16

Module for additional supply and exhaust - Series D (VB)

Product code: D2AVB-X

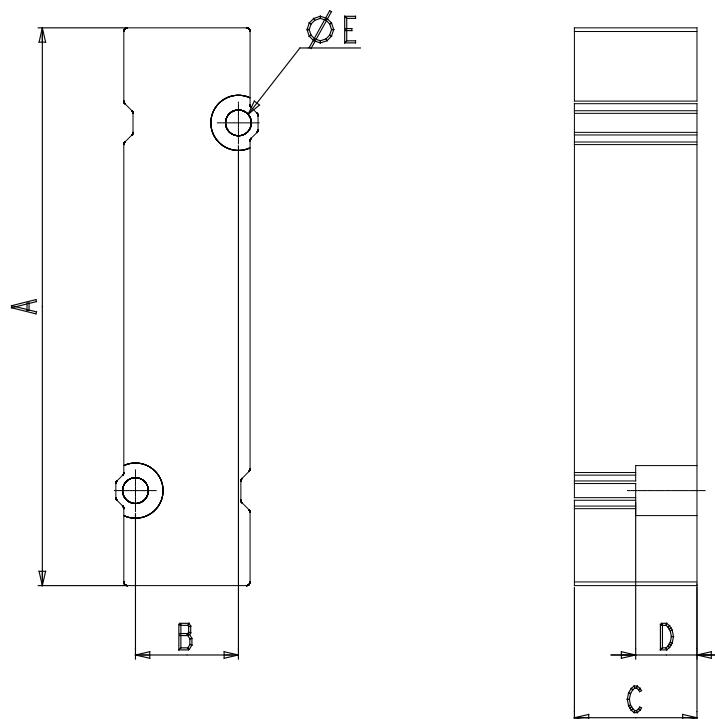

DIMENSIONS

A (mm)	65.0
B (mm)	12.0
C (mm)	15
D (mm)	12
E (mm)	3.3