

Blanking plate for manifolds - Series D (VB)

Product code: D4AVB-L

Datasheet creation date: 10/03/2025 11:24

Check the most updated document online [click here](#)

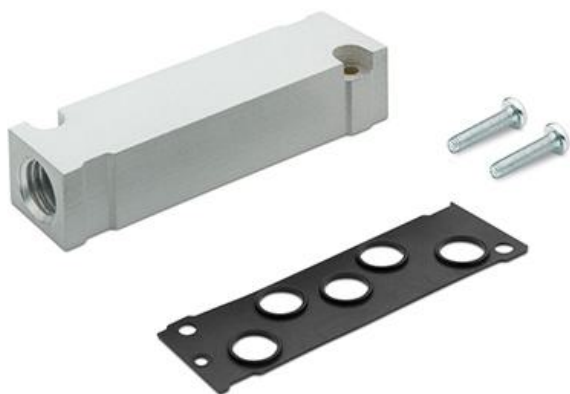

TECHNICAL DATA

	92.5
	19.0
	20
	15
	4.2

Blanking plate for manifolds - Series D (VB)

Product code: D4AVB-L

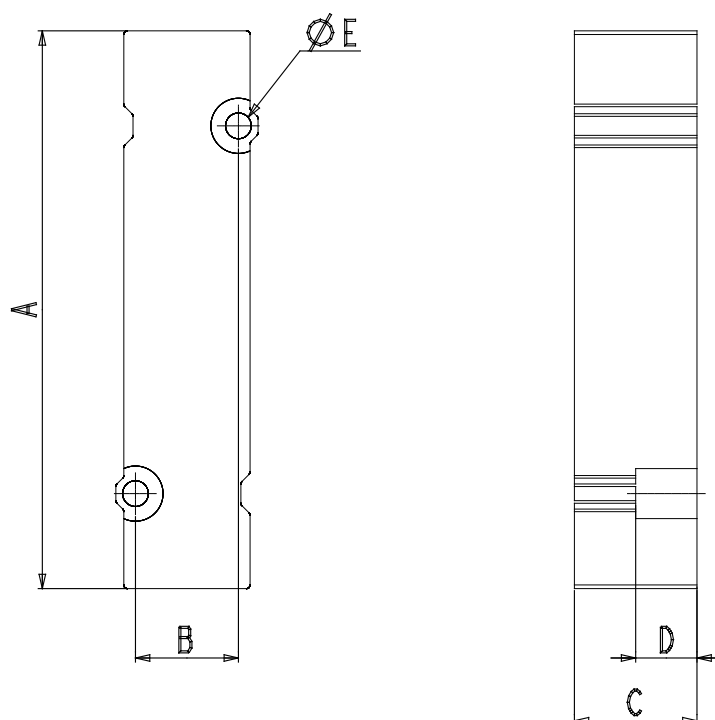

DIMENSIONS

	92.5
	19.0
	20
	15
	4.2