

Manifolds for valves with outlets on the body Size 10,5-25 - Series D (VA)

Product code: DCA10-8

Datasheet creation date: 07/03/2025 16:20

Check the most updated document online [click here](#)



TECHNICAL DATA

Series	DC
Manifold for type VA valves	A = For type VA valves
Size (mm)	1 = 10.5 mm
Body type	0 = body for sub-base assembly
Number of positions	8
Manifolds length (mm)	109.0

Manifolds for valves with outlets on the body Size 10,5-25 - Series D (VA)

Product code: DCA10-8

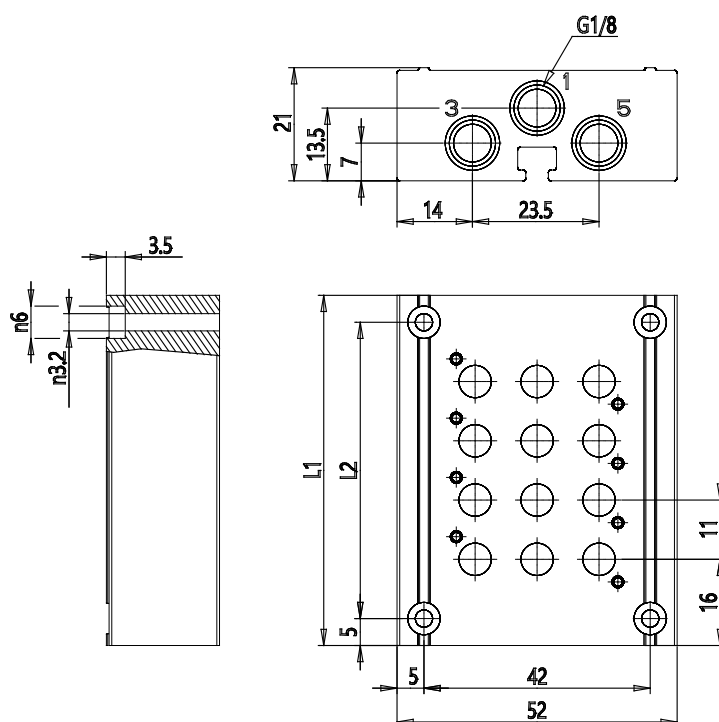

DIMENSIONS

Series	DC
Manifold for type VA valves	A = For type VA valves
Size (mm)	1 = 10.5 mm
Body type	0 = body for sub-base assembly
Number of positions	8
Manifolds length (mm)	109.0