

## Manifolds for valves with outlets on the body Size 10,5-25 - Series D (VA)

Product code: DCA20-18

Datasheet creation date: 07/03/2025 16:20

Check the most updated document online [click here](#)



### TECHNICAL DATA

<b>Series</b>	DC
<b>Manifold for type VA valves</b>	A = For type VA valves
<b>Size (mm)</b>	2 = 16 mm
<b>Body type</b>	0 = body for sub-base assembly
<b>Number of positions</b>	18
<b>Manifolds length (mm)</b>	312.0

## Manifolds for valves with outlets on the body Size 10,5-25 - Series D (VA)

Product code: DCA20-18

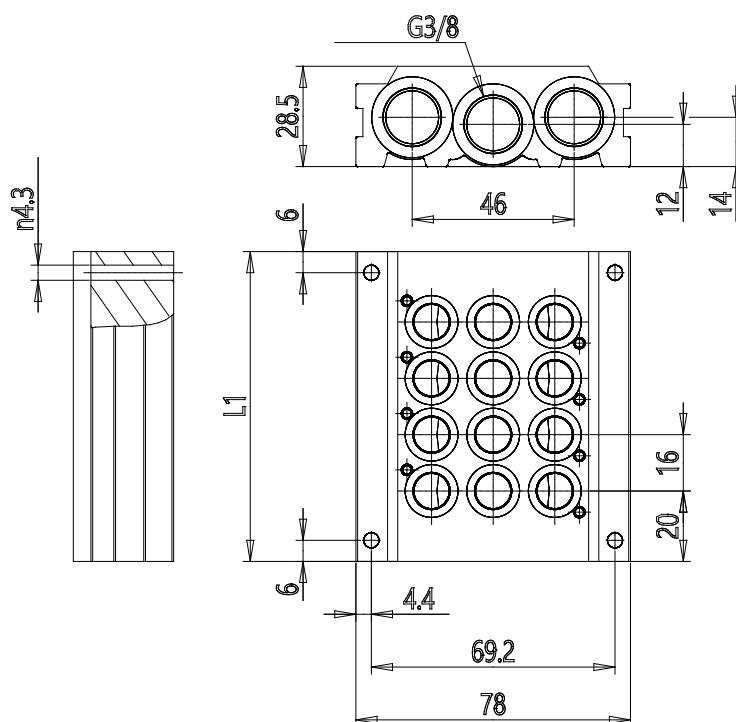

### DIMENSIONS

<b>Series</b>	DC
<b>Manifold for type VA valves</b>	A = For type VA valves
<b>Size (mm)</b>	2 = 16 mm
<b>Body type</b>	0 = body for sub-base assembly
<b>Number of positions</b>	18
<b>Manifolds length (mm)</b>	312.0