

Manifolds for valves with outlets on the body Size 10,5-25 - Series D (VA)

Product code: DCA20-4

Datasheet creation date: 07/03/2025 16:20

Check the most updated document online [click here](#)



TECHNICAL DATA

| | |
|------------------------------------|--------------------------------|
| Series | DC |
| Manifold for type VA valves | A = For type VA valves |
| Size (mm) | 2 = 16 mm |
| Body type | 0 = body for sub-base assembly |
| Number of positions | 4 |
| Manifolds length (mm) | 88.0 |

Manifolds for valves with outlets on the body Size 10,5-25 - Series D (VA)

Product code: DCA20-4

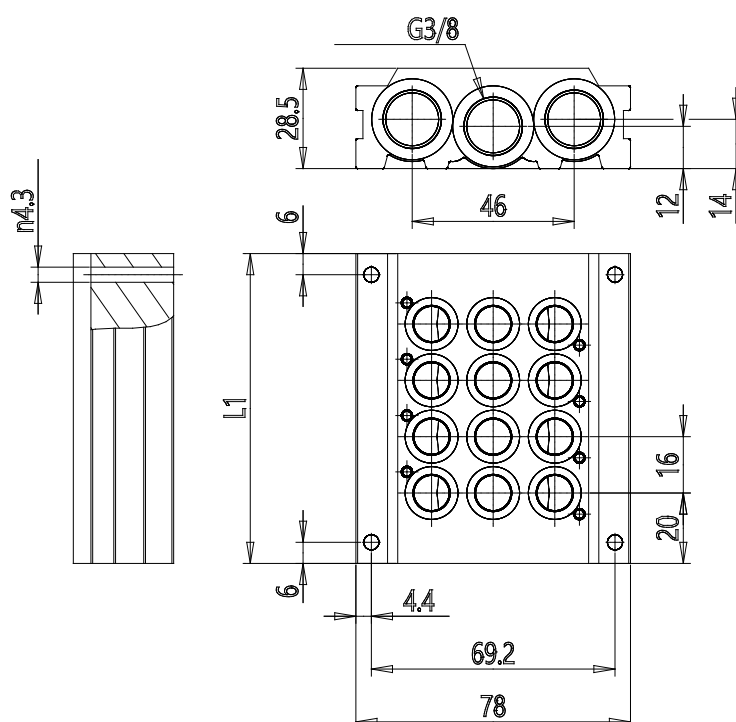

DIMENSIONS

| | |
|------------------------------------|--------------------------------|
| Series | DC |
| Manifold for type VA valves | A = For type VA valves |
| Size (mm) | 2 = 16 mm |
| Body type | 0 = body for sub-base assembly |
| Number of positions | 4 |
| Manifolds length (mm) | 88.0 |