

Manifold - Series D (VB)

Product code: DCB10-12

Datasheet creation date: 07/03/2025 16:21

Check the most updated document online [click here](#)



TECHNICAL DATA

Series	DC
Manifolds for valves model VB	B = For type VB valves
Size	1 = 10.5 mm
Servo-Pilot Supply	0 = Kit included for internal/external servo-pilot supply
Number of position	12
Manifolds length (mm)	157

Manifold - Series D (VB)

Product code: DCB10-12

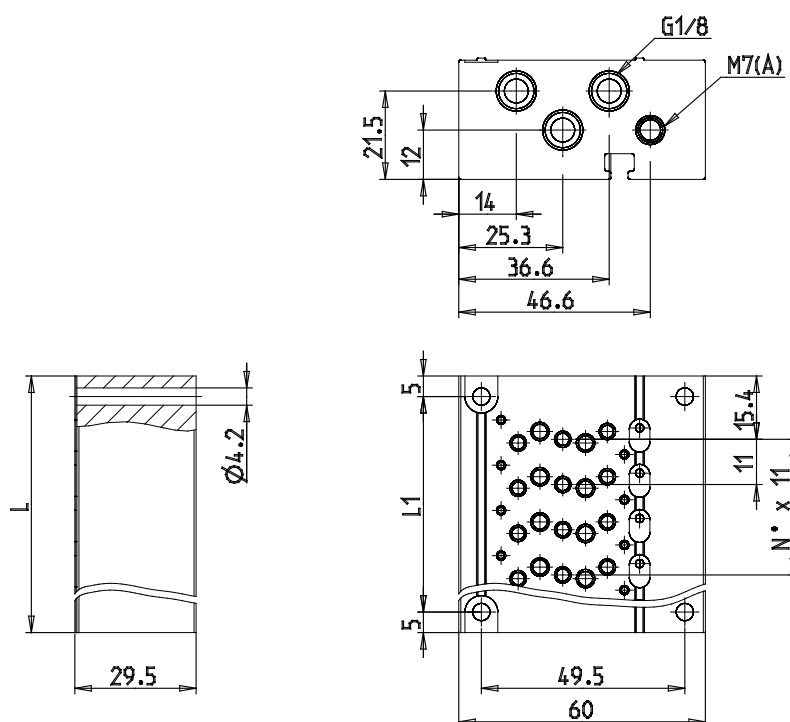

DIMENSIONS

Series	DC
Manifolds for valves model VB	B = For type VB valves
Size	1 = 10.5 mm
Servo-Pilot Supply	0 = Kit included for internal/external servo-pilot supply
Number of position	12
Manifolds length (mm)	157