

## Manifold - Series D (VB)

Product code: DCB10-17

Datasheet creation date: 07/03/2025 16:22

Check the most updated document online [click here](#)



### TECHNICAL DATA

<b>Series</b>	DC
<b>Manifolds for valves model VB</b>	B = For type VB valves
<b>Size</b>	1 = 10.5 mm
<b>Servo-Pilot Supply</b>	0 = Kit included for internal/external servo-pilot supply
<b>Number of position</b>	17
<b>Manifolds length (mm)</b>	212

## Manifold - Series D (VB)

Product code: DCB10-17

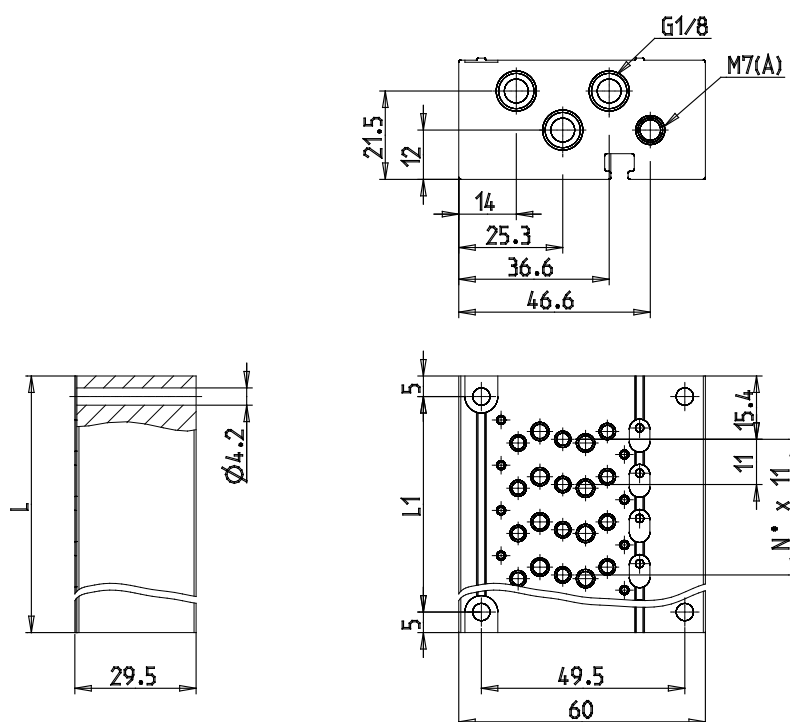

### DIMENSIONS

<b>Series</b>	DC
<b>Manifolds for valves model VB</b>	B = For type VB valves
<b>Size</b>	1 = 10.5 mm
<b>Servo-Pilot Supply</b>	0 = Kit included for internal/external servo-pilot supply
<b>Number of position</b>	17
<b>Manifolds length (mm)</b>	212