

Manifold - Series D (VB)

Product code: DCB40-8

Datasheet creation date: 07/03/2025 16:24

Check the most updated document online [click here](#)



TECHNICAL DATA

| | |
|--------------------------------------|---|
| Series | DC |
| Manifolds for valves model VB | B = For type VB valves |
| Size | 4 = 25 mm |
| Servo-Pilot Supply | 0 = Kit included for internal/external servo-pilot supply |
| Number of position | 8 |
| Manifolds length (mm) | 251 |

Manifold - Series D (VB)

Product code: DCB40-8

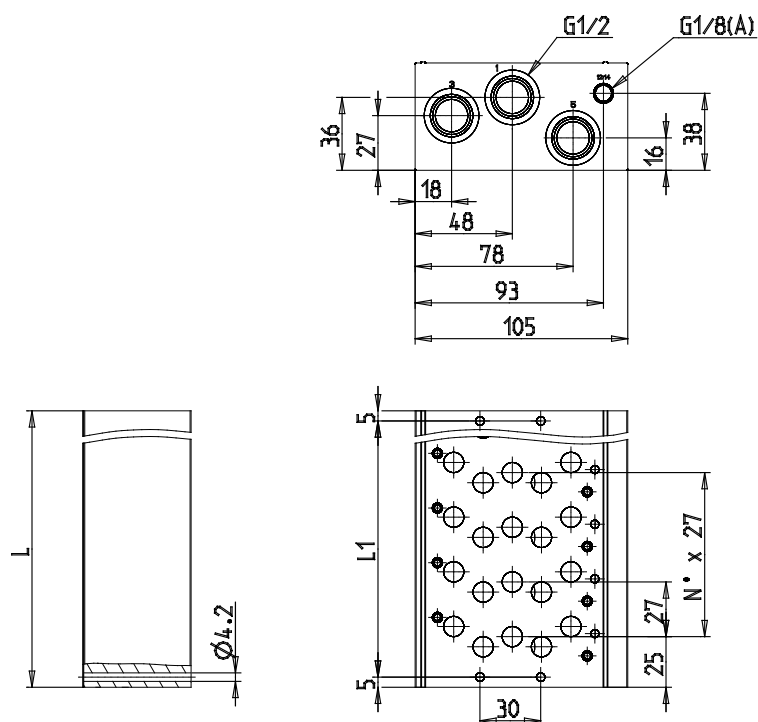

DIMENSIONS

| | |
|--------------------------------------|---|
| Series | DC |
| Manifolds for valves model VB | B = For type VB valves |
| Size | 4 = 25 mm |
| Servo-Pilot Supply | 0 = Kit included for internal/external servo-pilot supply |
| Number of position | 8 |
| Manifolds length (mm) | 251 |