

Integrated field-oriented control drive - Series DRVI

Product code: DRVI-24ST022-0E-PN

Datasheet creation date: 07/03/2025 15:51

Check the most updated document online [click here](#)



TECHNICAL DATA

Series	DRVI
Motor flange	24 = Nema 24
Motor type	ST = stepper
Torque	022 = 2,2 Nm
Motor brake	0 = no brake
Encoder	E = absolute single turn encoder
Protocol	PN = Profinet
Safety function	= standard

Integrated field-oriented control drive - Series DRVI

Product code: DRVI-24ST022-0E-PN

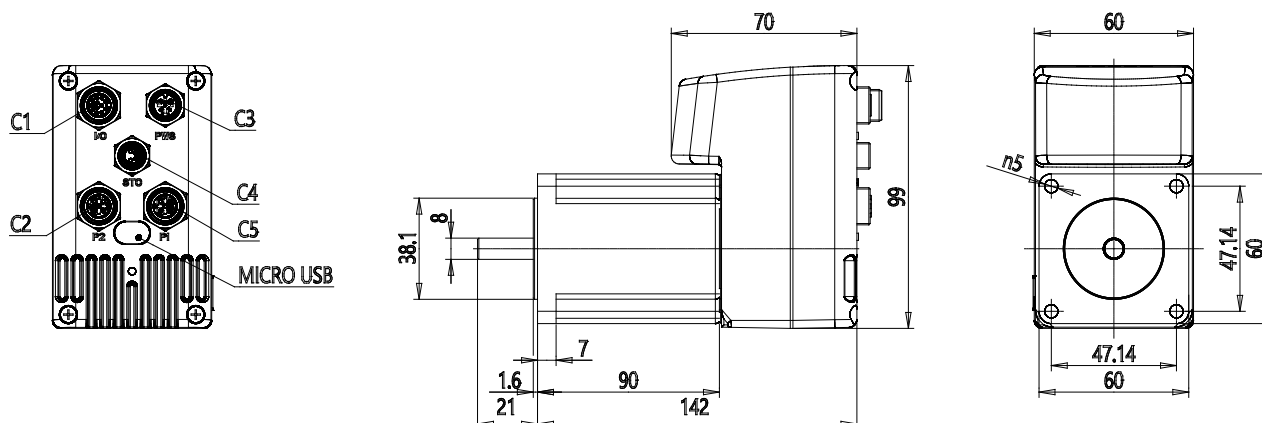

DIMENSIONS

Series	DRVI
Motor flange	24 = Nema 24
Motor type	ST = stepper
Torque	022 = 2,2 Nm
Motor brake	0 = no brake
Encoder	E = absolute single turn encoder
Protocol	PN = Profinet
Safety function	= standard