

Integrated field-oriented control drive - Series DRVI

Product code: DRVI-24ST022-0E-PNSF

Datasheet creation date: 07/03/2025 15:51

Check the most updated document online [click here](#)



TECHNICAL DATA

| | |
|------------------------|--------------------------------------|
| Series | DRVI |
| Motor flange | 24 = Nema 24 |
| Motor type | ST = stepper |
| Torque | 022 = 2,2 Nm |
| Motor brake | 0 = no brake |
| Encoder | E = absolute single turn encoder |
| Protocol | PN = Profinet |
| Safety function | SF = Safe torque off (not certified) |

Integrated field-oriented control drive - Series DRVI

Product code: DRVI-24ST022-0E-PNSF

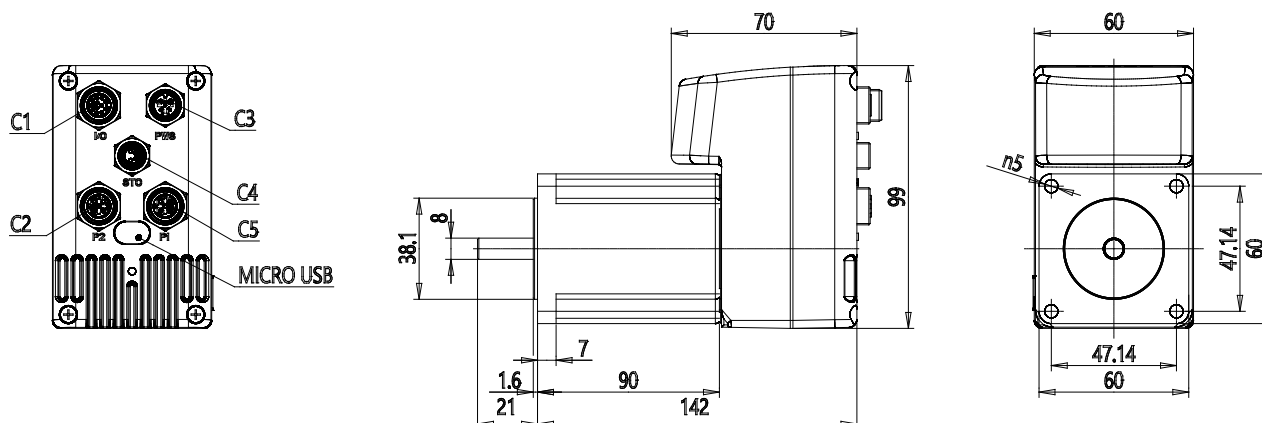

DIMENSIONS

| | |
|------------------------|--------------------------------------|
| Series | DRVI |
| Motor flange | 24 = Nema 24 |
| Motor type | ST = stepper |
| Torque | 022 = 2,2 Nm |
| Motor brake | 0 = no brake |
| Encoder | E = absolute single turn encoder |
| Protocol | PN = Profinet |
| Safety function | SF = Safe torque off (not certified) |