

Valves and solenoid valves - Series EN

Product code: EN530-11-P13

Datasheet creation date: 20/05/2026 08:44

Check the most updated document online [click here](#)



TECHNICAL DATA

Series	EN
Function	5 = 5/2 (5 ports/2 positions)
Size	3 = size 16
Body type (mm)	0 = body for sub-base
Operation	11 = electro-pneumatic, bistable
Type of solenoid	P13 = 24V DC - 1W

Valves and solenoid valves - Series EN

Product code: EN530-11-P13

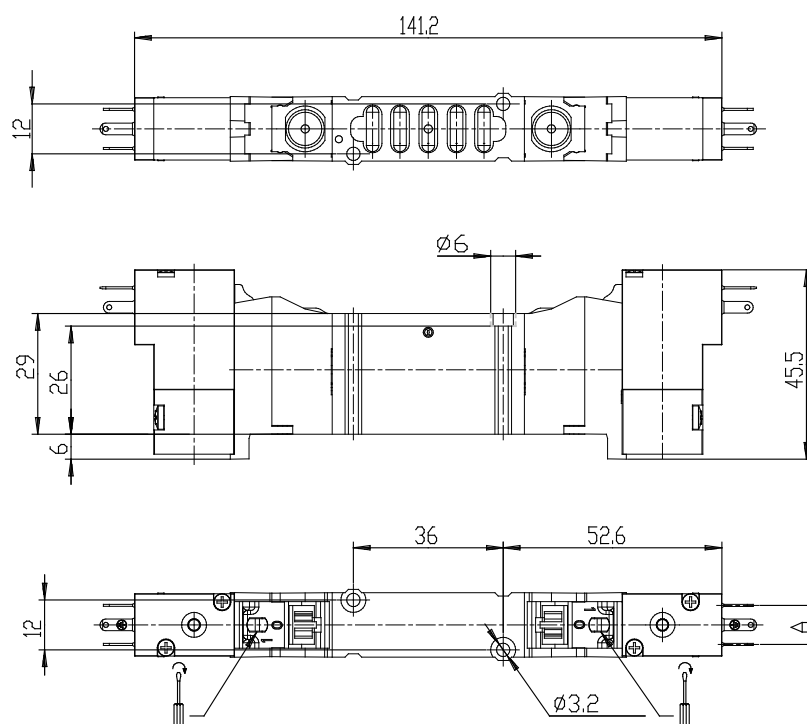

DIMENSIONS

Series	EN
Function	5 = 5/2 (5 ports/2 positions)
Size	3 = size 16
Body type (mm)	0 = body for sub-base
Operation	11 = electro-pneumatic, bistable
Type of solenoid	P13 = 24V DC - 1W