

Valves and solenoid valves - Series EN

Product code: EN531-16-PN4

Datasheet creation date: 20/05/2026 06:50

Check the most updated document online [click here](#)



TECHNICAL DATA

Series	EN
Function	5 = 5/2 (5 ports/2 positions)
Size	3 = size 16
Body type (mm)	1 = body with threaded ports
Operation	16 = electro-pneumatic, monostable
Type of solenoid	PN4 = 48V DC - 2W

Valves and solenoid valves - Series EN

Product code: EN531-16-PN4

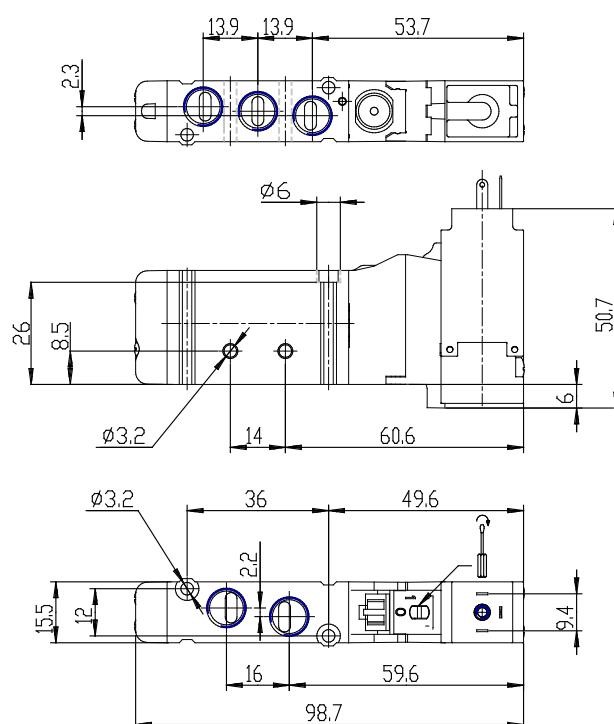

DIMENSIONS

Series	EN
Function	5 = 5/2 (5 ports/2 positions)
Size	3 = size 16
Body type (mm)	1 = body with threaded ports
Operation	16 = electro-pneumatic, monostable
Type of solenoid	PN4 = 48V DC - 2W