

Valves and solenoid valves - Series EN

Product code: EN550-16-W53

Datasheet creation date: 20/05/2026 08:43

Check the most updated document online [click here](#)



TECHNICAL DATA

Series	EN
Function	5 = 5/2 (5 ports/2 positions)
Size	5 = size 19
Body type (mm)	0 = body for sub-base
Operation	16 = electro-pneumatic, monostable
Type of solenoid	W53 = 24V DC - 2W

Valves and solenoid valves - Series EN

Product code: EN550-16-W53

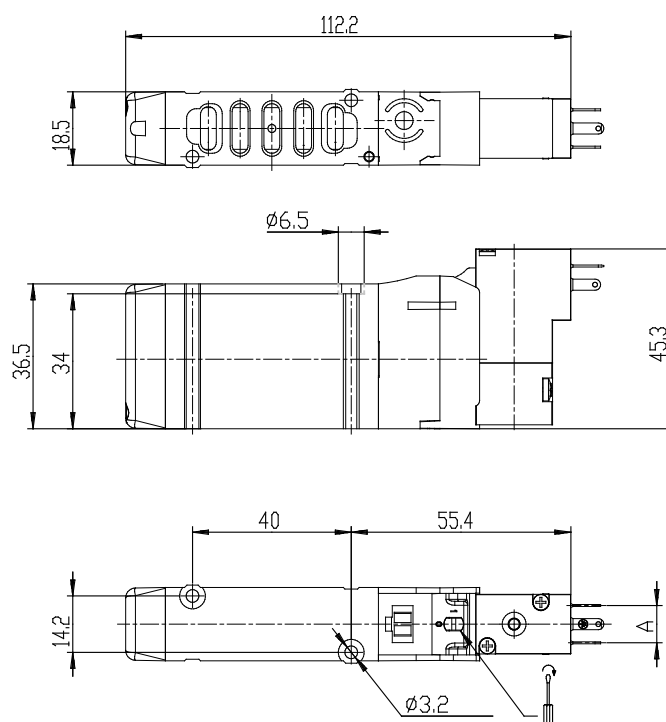

DIMENSIONS

Series	EN
Function	5 = 5/2 (5 ports/2 positions)
Size	5 = size 19
Body type (mm)	0 = body for sub-base
Operation	16 = electro-pneumatic, monostable
Type of solenoid	W53 = 24V DC - 2W