

Manifold - Series EN 19

Product code: EN551-1004

Datasheet creation date: 20/05/2026 09:25

Check the most updated document online [click here](#)



■ TECHNICAL DATA

Mod.	EN551-1004
Number of positions	4

Manifold - Series EN 19

Product code: EN551-1004

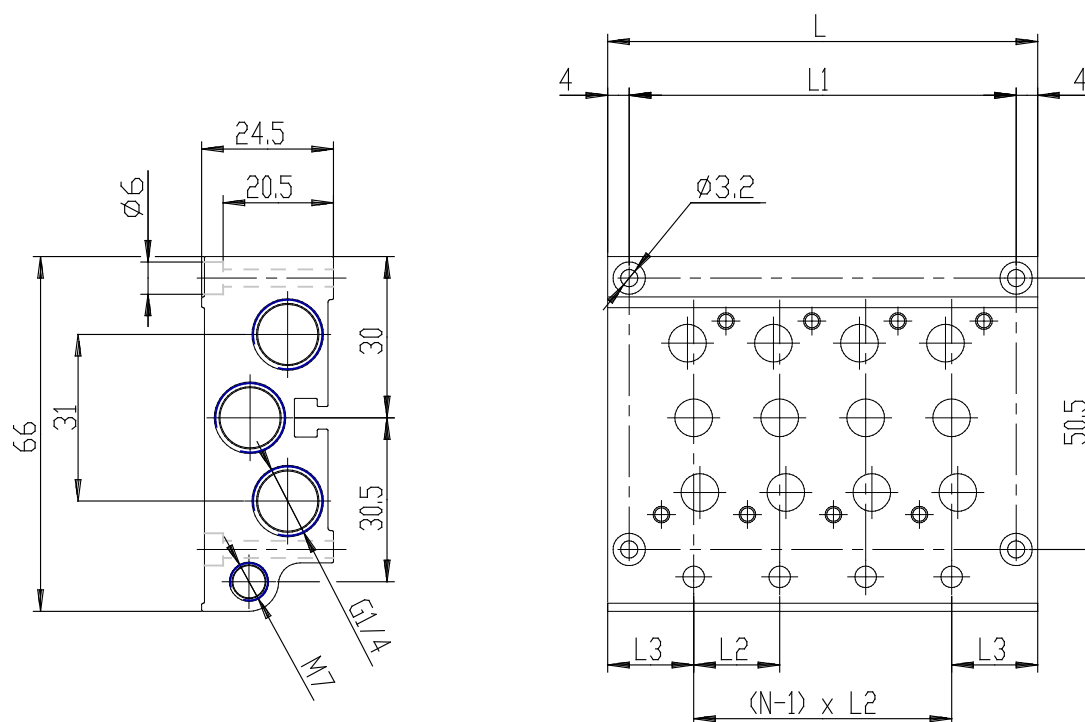

DIMENSIONS

L (mm)	91
L1 (mm)	83
L2 (mm)	19
L3 (mm)	17