

Manifold - Series EN 19

Product code: EN551-1005

Datasheet creation date: 20/05/2026 08:44

Check the most updated document online [click here](#)



■ TECHNICAL DATA

Mod.	EN551-1005
Number of positions	5

Manifold - Series EN 19

Product code: EN551-1005

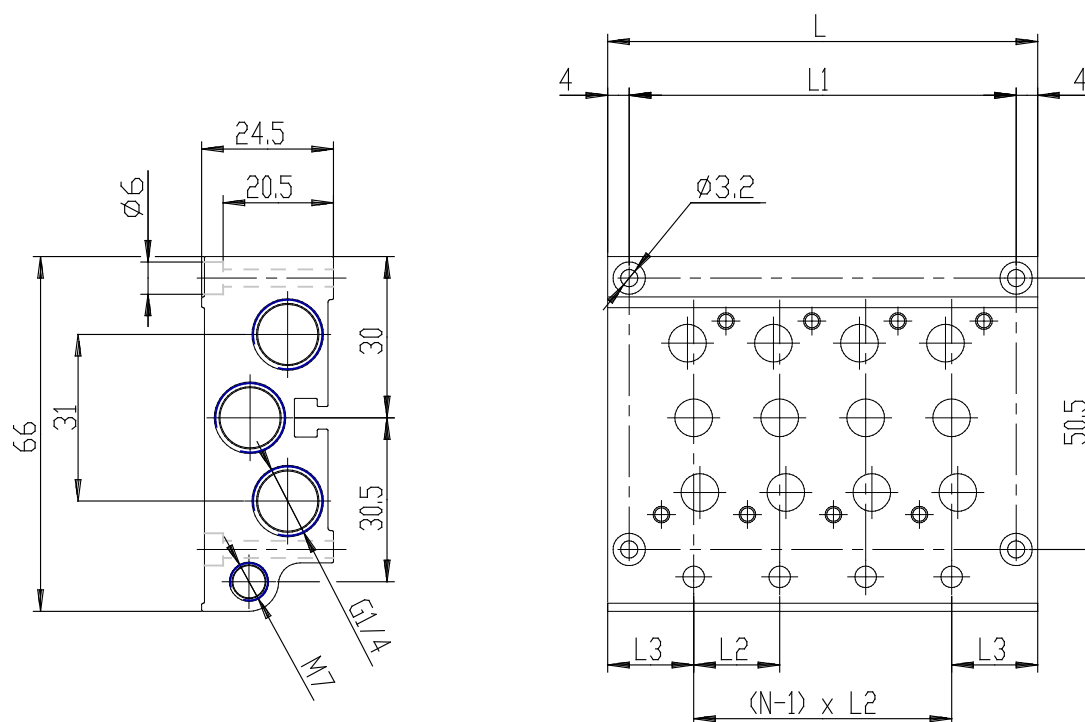

DIMENSIONS

L (mm)	110
L1 (mm)	102
L2 (mm)	19
L3 (mm)	17