

## Valves and solenoid valves - Series EN

Product code: EN551-16-PN4

Datasheet creation date: 20/05/2026 06:51

Check the most updated document online [click here](#)



### TECHNICAL DATA

<b>Series</b>	EN
<b>Function</b>	5 = 5/2 (5 ports/2 positions)
<b>Size</b>	5 = size 19
<b>Body type (mm)</b>	1 = body with threaded ports
<b>Operation</b>	16 = electro-pneumatic, monostable
<b>Type of solenoid</b>	PN4 = 48V DC - 2W

## Valves and solenoid valves - Series EN

Product code: EN551-16-PN4

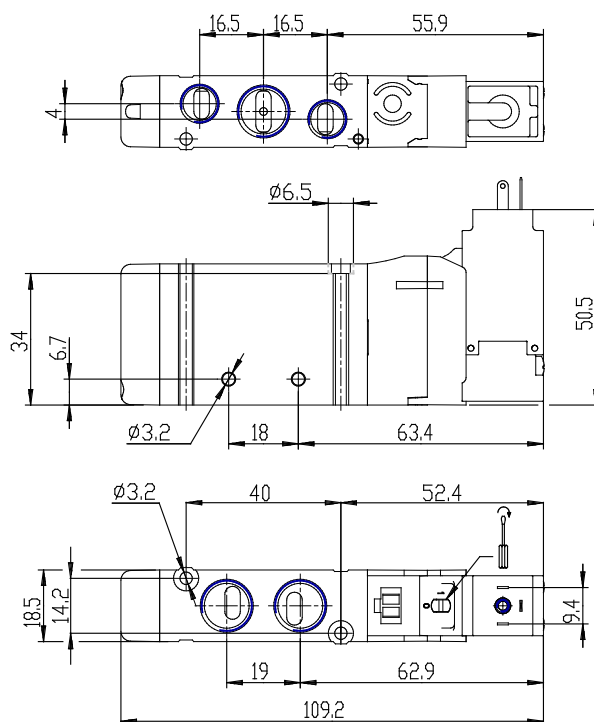

### DIMENSIONS

<b>Series</b>	EN
<b>Function</b>	5 = 5/2 (5 ports/2 positions)
<b>Size</b>	5 = size 19
<b>Body type (mm)</b>	1 = body with threaded ports
<b>Operation</b>	16 = electro-pneumatic, monostable
<b>Type of solenoid</b>	PN4 = 48V DC - 2W