

## Valves and solenoid valves - Series EN

Product code: EN651-11-PN3

Datasheet creation date: 20/05/2026 06:52

Check the most updated document online [click here](#)



### TECHNICAL DATA

<b>Series</b>	EN
<b>Function</b>	6 = 5/3 centre closed
<b>Size</b>	5 = size 19
<b>Body type (mm)</b>	1 = body with threaded ports
<b>Operation</b>	11 = electro-pneumatic, bistable
<b>Type of solenoid</b>	PN3 = 24V DC - 1W

## Valves and solenoid valves - Series EN

Product code: EN651-11-PN3

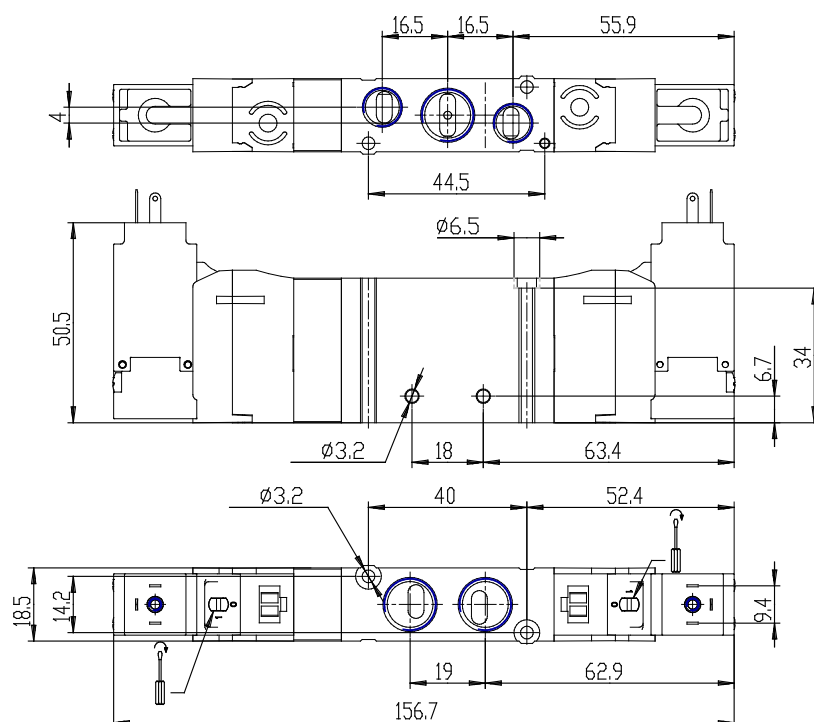

### DIMENSIONS

<b>Series</b>	EN
<b>Function</b>	6 = 5/3 centre closed
<b>Size</b>	5 = size 19
<b>Body type (mm)</b>	1 = body with threaded ports
<b>Operation</b>	11 = electro-pneumatic, bistable
<b>Type of solenoid</b>	PN3 = 24V DC - 1W