

Centre trunnion - Mod. F

Product code: F-40

Datasheet creation date: 07/03/2025 16:02

Check the most updated document online [click here](#)



TECHNICAL DATA

Mod.	F-40
------	------

Centre trunnion - Mod. F

Product code: F-40

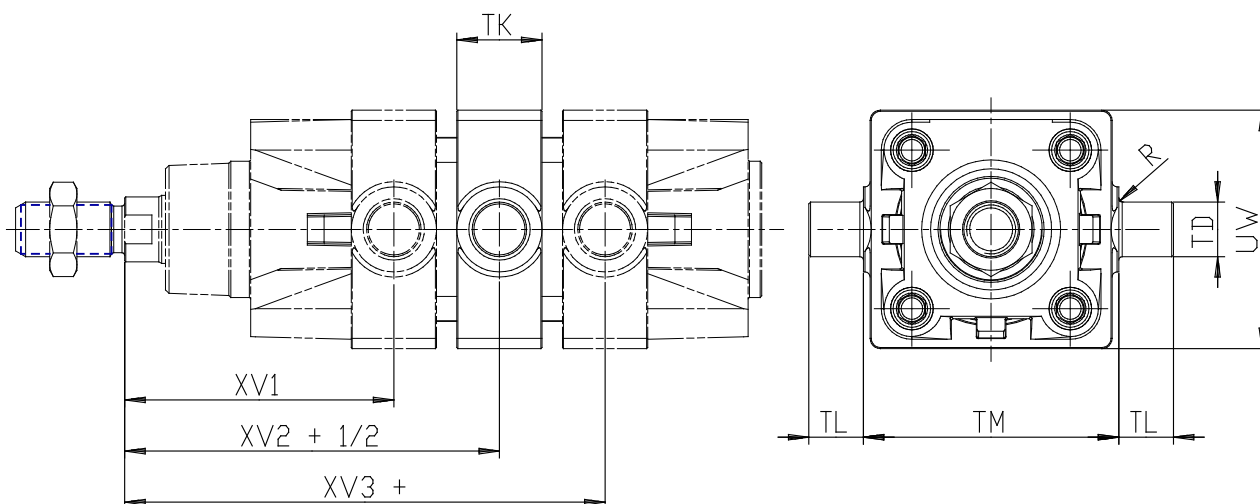

DIMENSIONS

XV1 (mm)	69.0
XV2 (mm)	82.5
XV3 (mm)	96.0
TM (mm)	63
TK (mm)	20
TD (mm)	16
TL (mm)	16
UW (mm)	60
R (mm)	1.00