

## Centre trunnion - Mod. F-41

Product code: F-41-160

Datasheet creation date: 07/03/2025 15:58

Check the most updated document online [click here](#)



### ■ TECHNICAL DATA

Mod.	F-41-160
------	----------

## Centre trunnion - Mod. F-41

Product code: F-41-160

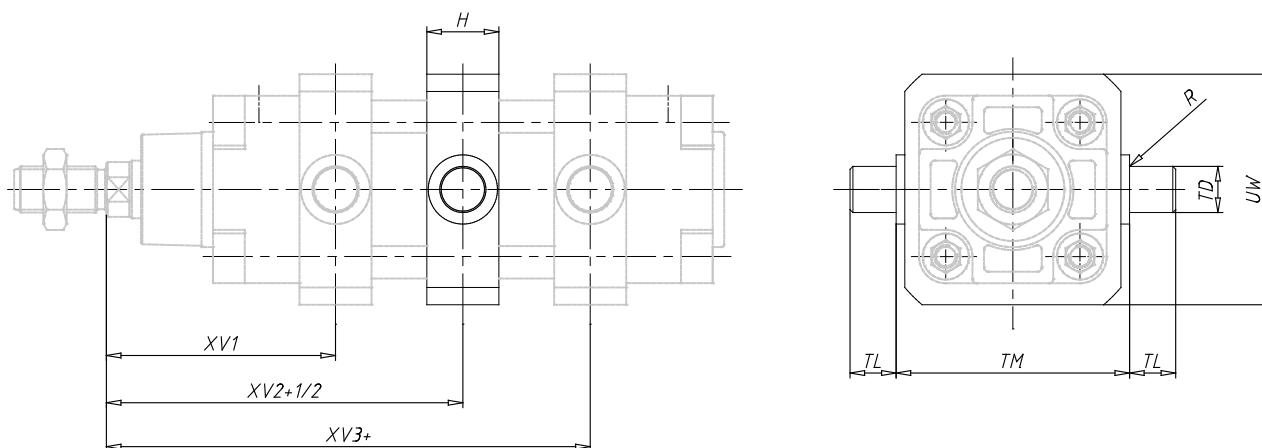

### DIMENSIONS

<b>XV1 (mm)</b>	145
<b>XV2 (mm)</b>	170
<b>XV3 (mm)</b>	195
<b>TM (mm)</b>	200
<b>TK (mm)</b>	40
<b>TD (mm)</b>	32
<b>TL (mm)</b>	32
<b>UW (mm)</b>	190
<b>R (mm)</b>	0.2