

Front/rear spot faced trunnion Mod. FN - Mod. FN

Product code: FN-100

Datasheet creation date: 07/03/2025 16:05

Check the most updated document online [click here](#)



TECHNICAL DATA

Series	32
Mod.	FN-100
Diameter (mm)	Ø100

Front/rear spot faced trunnion Mod. FN - Mod. FN

Product code: FN-100

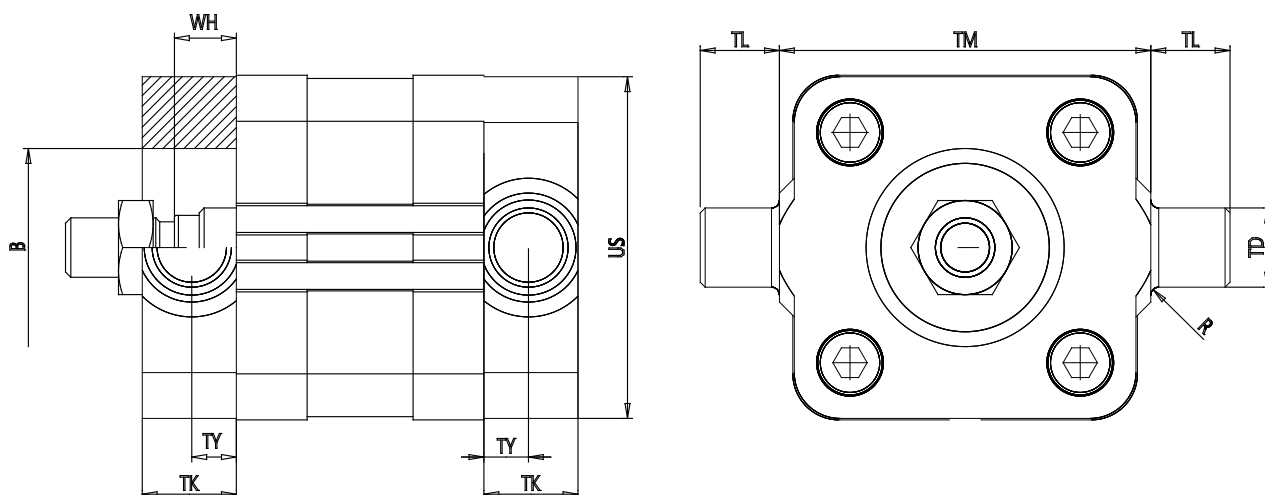

DIMENSIONS

TK (TK / mm)	29
TY (TY / mm)	14.0
WH (WH / mm)	9.7
B (B / mm)	55
XH (XH / mm)	37.0
XL (XL / mm)	203.0
US (US / mm)	125
TL (TL / mm)	25
TM (TM / mm)	132
TD (TD / mm)	25
R (R / mm)	2.0