

## Front/rear spot faced trunnion Mod. FN - Mod. FN

Product code: FN-32

Datasheet creation date: 07/03/2025 16:05

Check the most updated document online [click here](#)



### TECHNICAL DATA

Series	32
Mod.	FN-32
Diameter (mm)	Ø32

## Front/rear spot faced trunnion Mod. FN - Mod. FN

Product code: FN-32

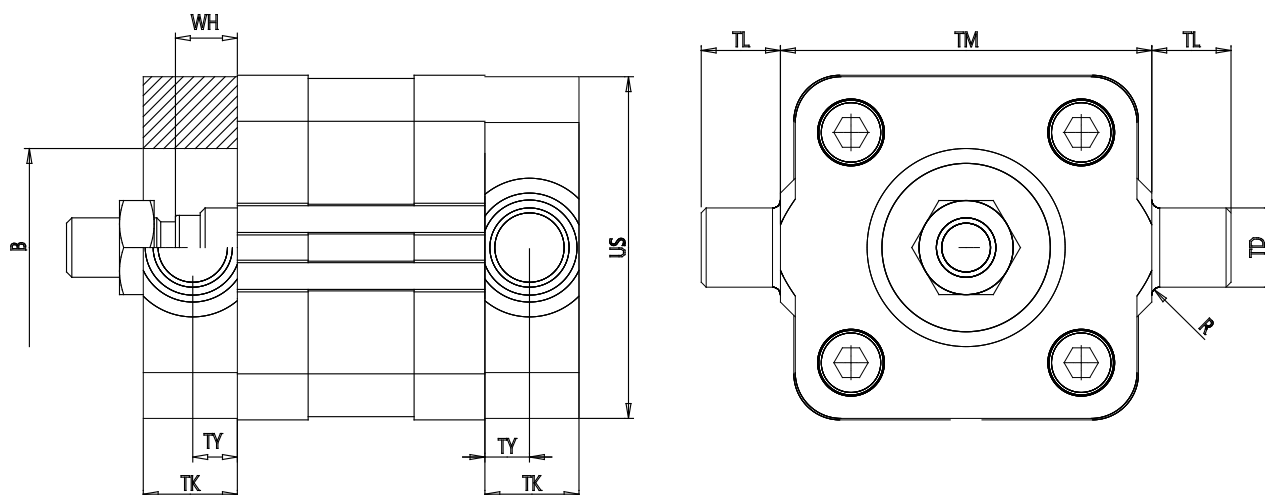

### DIMENSIONS

TK (TK / mm)	14
TY (TY / mm)	6.5
WH (WH / mm)	7.0
B (B / mm)	30
XH (XH / mm)	19.5
XL (XL / mm)	126.5
US (US / mm)	46
TL (TL / mm)	12
TM (TM / mm)	50
TD (TD / mm)	12
R (R / mm)	1.0