

Front/rear spot faced trunnion Mod. FN - Mod. FN

Product code: FN-40

Datasheet creation date: 07/03/2025 16:05

Check the most updated document online [click here](#)



TECHNICAL DATA

Series	32
Mod.	FN-40
Diameter (mm)	Ø40

Front/rear spot faced trunnion Mod. FN - Mod. FN

Product code: FN-40

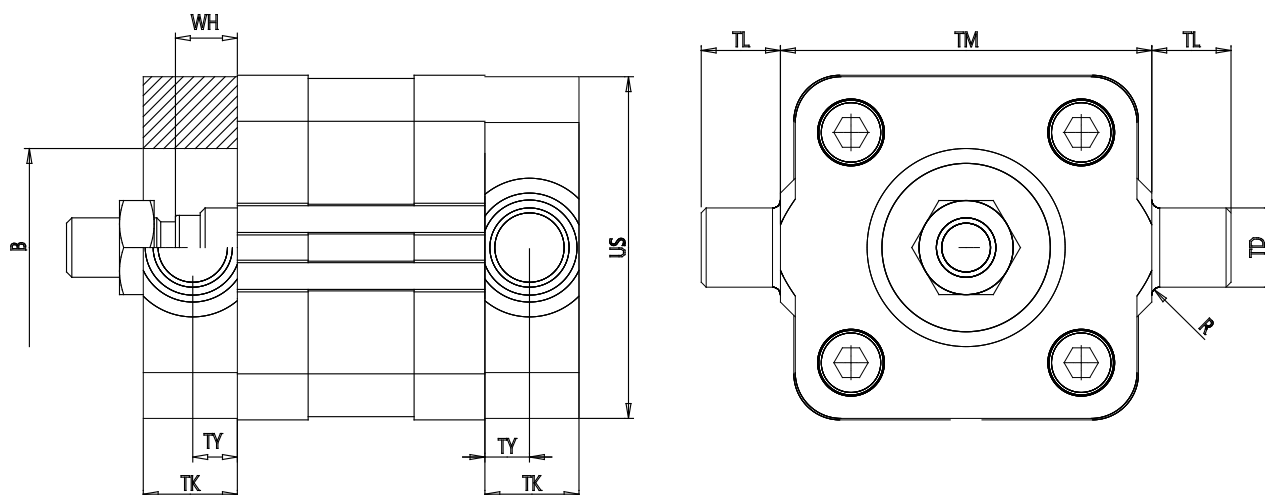

DIMENSIONS

TK (TK / mm)	19
TY (TY / mm)	9.0
WH (WH / mm)	7.0
B (B / mm)	35
XH (XH / mm)	21.0
XL (XL / mm)	144.0
US (US / mm)	59
TL (TL / mm)	16
TM (TM / mm)	63
TD (TD / mm)	16
R (R / mm)	1.5