

Kit to connect the gearbox - enhanced series - Mod. FRH

Product code: FRH-5E-50

Datasheet creation date: 07/03/2025 15:39

Check the most updated document online [click here](#)



■ TECHNICAL DATA

Mod.	FRH-5E-50
Size (mm)	50

Kit to connect the gearbox - enhanced series - Mod. FRH

Product code: FRH-5E-50

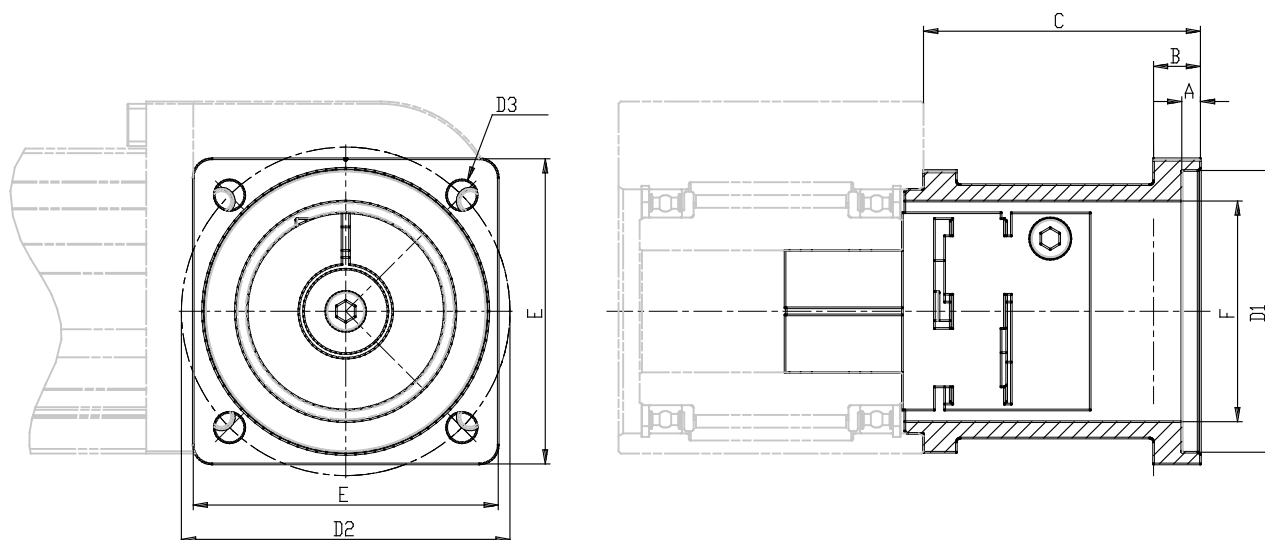

DIMENSIONS

D1 (mm)	0
A (mm)	4
BCD (mm)	52
D2 (mm)	40
D3 (mm)	5.5
B (mm)	8
C (mm)	51
E (mm)	50
F (mm)	34
P	170