

Flow sensor - Series FSX

Product code: FSX-212Y-E050-EPT00-0R00

Datasheet creation date: 20/05/2026 08:27

Check the most updated document online [click here](#)



TECHNICAL DATA

Series	FSX
Size	2
Ports (IN - OUT)	12 = G1/2 (native)
Bracket	Y = central clamp type Y with wall-mounting flange
Display	E = without display
Flow rate range	050 = 5.000 l/min (ANR)
Output specifications	E = Ethernet I/P
Sensor reading	PT0 = Pressure and temperature sensor
Closed loop flow	0 = Without proportional flow valve
Draining of condensate	0 = semiautomatico-manuale
Flow direction	R = left to right (standard)
Certifications	00 = none

Flow sensor - Series FSX

Product code: FSX-212Y-E050-EPT00-0R00

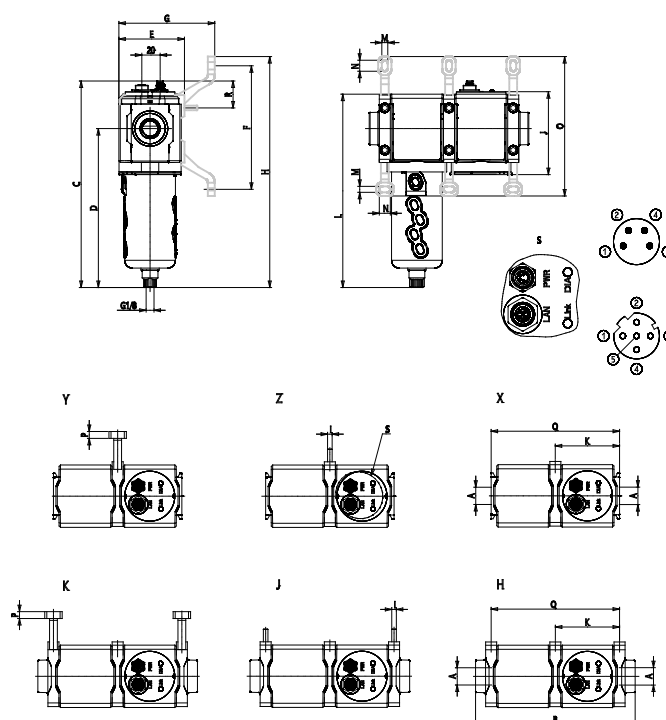

DIMENSIONS

A	G1/2
B (mm)	140
C (mm)	226
D (mm)	174
E (mm)	72
F (mm)	135.0
G (mm)	0
H (mm)	252
I	M5
J (mm)	91
K (mm)	70
L (mm)	211
M (mm)	6.5
N (mm)	12
O (mm)	152
P (mm)	7.5
Q (mm)	140
R (mm)	18